





RAIN 120 INOX 220V / 50 Hz

FREESTANDING WATER COOLERS

FEATURES CARACTERÍSTICAS

- ▶ **THE ICE BANK WITH DOUBLE COIL IN THE WG VERSIONS IMPROVES THE EFFICIENCY OF SIMULTANEOUS CHILLED AND SPARKLING WATER DISPENSING.**
EL BANCO DE HIELO DE DOBLE SERPENTÍN, EN LAS VERSIONES WG, MEJORA LA EFICACIA DE LA DISPENSACIÓN SIMULTÁNEA DE AGUA HELADA Y DE AGUA CON GAS.
- ▶ **STANDARD: WATER PRESSURE REDUCER, CO2 REGULATOR FOR MODELS WITH SPARKLING WATER AND THE USE OF AISI 304 STAINLESS STEEL FOR THE SENSITIVE PARTS OF THE CASING.**
MODELO ESTÁNDAR: REDUCTOR DE PRESIÓN DEL AGUA, REGULADOR DE CO2 PARA LOS MODELOS DE AGUA CON GAS Y FABRICACIÓN DE LAS PARTES SENSIBLES DE LA CARCASA CON ACERO INOXIDABLE AISI 304.
- ▶ **AVAILABLE ON ALL MODELS, THE APPLICATION ENSURES BACTERIAL IMMUNITY FOR THE COOLER, PROVIDING PERMANENT AND CONSTANT PROTECTION AGAINST THE FORMATION OF BIOFILMS.**
LA APLICACIÓN DE ESTE SISTEMA, DISPONIBLE EN TODOS LOS MODELOS, ASEGURA LA INMUNIDAD BACTERIANA DEL ENFRIADOR, LO CUAL PROPORCIONA UNA PROTECCIÓN PERMANENTE Y CONSTANTE CONTRA LA FORMACIÓN DE BIOPELÍCULAS.
- ▶ **CHLORINE FILTERS AND PURIFIERS CAN BE FITTED TO IMPROVE THE TASTE AND AROMA OF THE WATER. AN ANTI-BACTERIAL UV SYSTEM, WATER METER AND TIMER COMPLETE THE RANGE OF ACCESSORIES AVAILABLE WITH THE FILTERING DEVICE.**
PUEDEN ADAPTARSE FILTROS DE CLORO Y PURIFICADORES CON EL FIN DE MEJORAR EL SABOR Y EL OLOR DEL AGUA. UN SISTEMA ANTIBACTERIANO POR UV, UN CONTADOR DE AGUA Y UN TEMPORIZADOR COMPLETAN LA GAMA DE ACCESORIOS DISPONIBLES, ADEMÁS DEL DISPOSITIVO DE FILTRADO.
- ▶ **RAIN120 INOX IS THE FLOOR STANDING MODEL. THE ROBUST, SOLID AND HIGH-PERFORMANCE PRODUCT INSTANTLY DISPENSES LARGE AMOUNTS OF STILL AND SPARKLING OR CHILLED AND ROOM-TEMPERATURE WATER.**
RAIN120 INOX ES EL MODELO DE PIE. SE TRATA DE UN PRODUCTO ROBUSTO, SÓLIDO Y DE ALTO RENDIMIENTO QUE DISPENSA INSTANTÁNEAMENTE GRANDES CANTIDADES DE AGUA CON O SIN GAS, FRÍA O A TEMPERATURA AMBIENTE.
- ▶ **THE SAFETY VALVE PREVENTS LEAKAGES CAUSED BY ACCIDENTAL FAULTS INSIDE THE MACHINE.**
LA VÁLVULA DE SEGURIDAD EVITA LAS FUGAS CAUSADAS POR DEFECTOS ACCIDENTALES EN EL INTERIOR DE LA MÁQUINA.
- ▶ **THROUGH THE ELECTRONIC CONTROL IT IS POSSIBLE TO SET THE QUANTITY OF WATER SUPPLIED AUTOMATICALLY -FLOW METER CONTROLLED DOSING-, THE TEMPERATURE OF THE ICE BANK, AND OTHER FUNCTIONS. OPERATION IS MONITORED IN REAL TIME.**
GRACIAS A SU SISTEMA DE CONTROL ELECTRÓNICO, SE PUEDE AJUSTAR AUTOMÁTICAMENTE LA CANTIDAD DE AGUA DISPENSADA -DOSIFICACIÓN CONTROLADA MEDIANTE CAUDALÍMETRO-, LA TEMPERATURA DEL BANCO DE HIELO Y OTRAS FUNCIONES. EL FUNCIONAMIENTO SE MONITORIZA EN TIEMPO REAL.



		WATER PRODUCTION PRODUCCIÓN DE AGUA		 (l)	 (mm)	 (mm)
		(l/h)	(usg/h)			
RAIN 120 INOX	✓	120	31,7	15	Width 480 Depth 405 Height 1.480	Width 1.300 Depth 900 Height 1.650

Base at 985mm. Base a 985mm.
Hollow height 311mm. Altura hueco 311mm.



RIGHT SIDE VIEW
VISTA LATERAL DERECHA

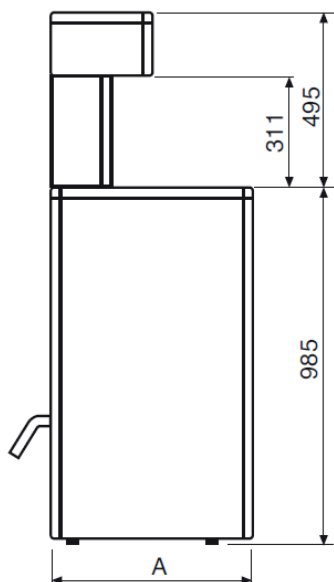

BACK VIEW
VISTA TRASERA

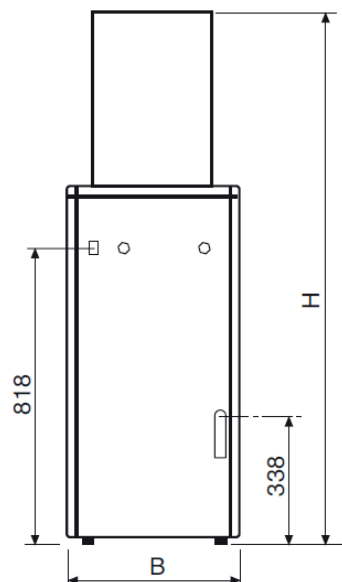

OPERATING CONDITIONS CONDICIONES DE OPERACIÓN

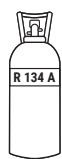
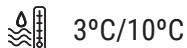

V	Hz	ph
220	50	1N

MODELS
MODELOS

RAIN 120 INOX



1/3



900



- -



-



45



- -



ITV ICE MAKERS, S.L.
POL. IND. SECTOR 13, AVDA. DELS HOSTALERS, 2
46394 RIBARROJA DE TURIA, VALENCIA, SPAIN
PHONE: +34 96 166 75 75 | FAX: +34 96 166 81 00
info@itv.es | www.itv.es



SERVICE
SERVICIO ASISTENCIA TÉCNICA
service@itv.es
Skype: ITV.Service
+34 961 667 639
8:00AM | 7:00PM



Subject to certain limitations and exclusions. Only spare parts.
Sujeto a limitaciones y exclusiones. Solo piezas de repuesto.



9000
9001
14001

