

# BIN SCS 150

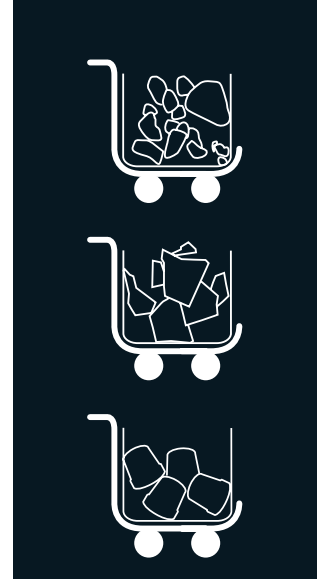

















## ICE BIN WITH CART FOR MODULAR MACHINES

### FEATURES CARATTERISTICHE

- ▶ **ICE BIN CAPACITY OF 140 KG (CART CAPACITY NOT INCLUDED)**  
SERBATOIO PER GHIACCIO CON CAPACITÀ DI 140 KG (CAPACITÀ DEL CARRELLO NON INCLUSA)
- ▶ **AISI 304 STAINLESS STEEL BIN**  
SERBATOIO DI ACCIAIO INOSSIDABILE QUALITÀ AISI 304
- ▶ **HARD SANITARY POLYETHYLENE VAT, RESISTANT TO BLOWS, AND SCRATCHES**  
CISTERNA INTERNA DI POLIETILENE SANITARIO DI ELEVATA DUREZZA, RESISTENTE AD URTI E ATTRITI
- ▶ **EASY CLEANING DESIGN®: SEAMLESS ONE-PIECE VAT WITH ROUNDED CORNERS, AVOIDING POSSIBLE DIRTY POINTS AND FACILITATING CLEANING**  
EASY CLEANING DESIGN®: CISTERNA INTERNA SENZA GIUNZIONI, IN UN UNICO PEZZO, CON ANGOLI ARROTONDATI PER ELIMINARE EVENTUALI PUNTI DI SPORCIZIA E FACILITARE LA PULIZIA
- ▶ **DRAINAGE SYSTEM THAT COLLECTS AND DRIVES THE WATER TO THE DRAIN KEEPING THE BIN AND FLOOR CLEAN & DRY**  
SISTEMA DI DRENAGGIO CHE RACCOGLIE E CONDUCE L'ACQUA ALLO SCARICO MANTENENDO IL SERBATOIO E IL PAVIMENTO PULITI E ASCIUTTI
- ▶ **LARGE CAPACITY EASY CART®, UP TO 112 KG OF ICE (70 KG WITH BUCKETS); ERGONOMIC, EASY TO MOVE WITH LITTLE EFFORT**  
EASY CART® CON ELEVATA CAPACITÀ, FINO A 112 KG DI GHIACCIO (70 KG CON CESTELLI) ED ERGONOMIC, FACILE DA SPOSTARE CON IL MINIMO SFORZO
- ▶ **EASY CART® HAS A BRAKING AND DRAINAGE SYSTEM**  
EASY CART® DISPONE DI SISTEMA FRENANTE E SCARICO
- ▶ **EASY CART® IS MADE OF SANITARY POLYETHYLENE, WITH SMOOTH SURFACE TO FACILITATE CLEANING. IT INCLUDES A COVER TO PREVENT DIRT FROM CONTAMINATING THE ICE**  
EASY CART® IN POLIETILENE SANITARIO, SENZA RUGOSITÀ PER FACILITARE LA PULIZIA. INCLUDE COPERCHIO PER EVITARE CHE LA POLVERE CONTAMINI IL GHIACCIO
- ▶ **BUCKETS FOR DISTRIBUTING ICE QUICKLY AND EFFORTLESSLY CAN BE INCLUDED**  
SI POSSONO INCLUDERE CESTELLI PER DISTRIBUIRE IL GHIACCIO RAPIDAMENTE E SENZA SFORZO



### RECOMMENDED MACHINES MACCHINE RACCOMANDATI

	MDP150/MR400/MP	SPIKA	QUASAR	ICE QUEEN	SCALA
 <b>RECOMMENDED</b> RACCOMANDATO	 2 MDP 150	 MS 220  MS 300 SLIM  1   2 MS 410		 IQ 150  IQ 200  IQ 400  IQ 550  IQ 550 SPLIT  G IQ 850 CO2  IQ 1100 SPLIT	
 <b>NOT RECOMMENDED</b> NO RACCOMANDATO	 MDP 150	 MS 220		 2 IQ 550 SPLIT  2 G IQ 850 CO2	 SCALA 400  SCALA 600

BIN SCS150

RIGHT SIDE VIEW  
VISTA LATERALE DESTRA

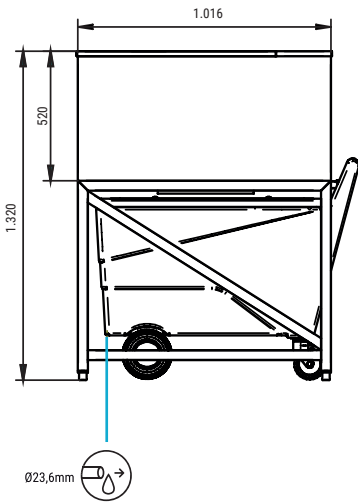

FRONTAL VIEW  
VISTA FRONTALE

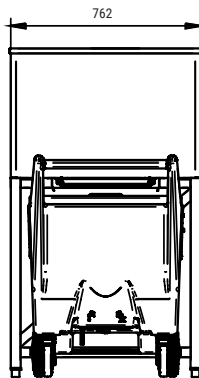

REAR VIEW  
VISTA POSTERIORE

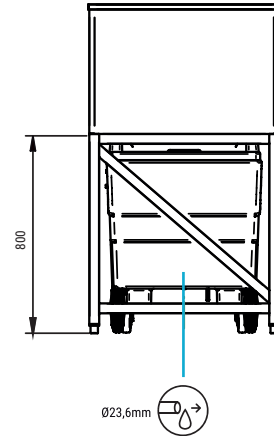

UPPER VIEW  
VISTA SUPERIORE

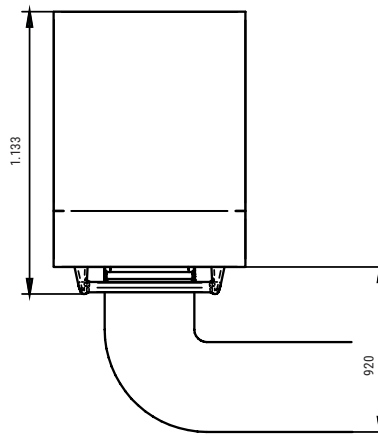

\* All measurements in mm.  
\* Tutte le misure in mm.

ACCESSORIES ACCESSORI

INCLUSO



WATER OUTLET HOSE  
TUBO DI SCARICO



ICE PADDLE  
PALA CON MANICO LUNGO



ICE PADDLE SUPPORT  
SUPPORTO PER LA PALA

NON INCLUSO (OPTIONAL)



BUCKETS  
CESTELLI

MODELS  
MODELLI



BIN SCS 150

140

110

252

Width 762  
Depth\* 1.016  
Height 1.320

75

Width 962  
Depth 1.216  
Height 1.520

82

1,78

\*WITHOUT DOOR SENZA SPORTELLINO