

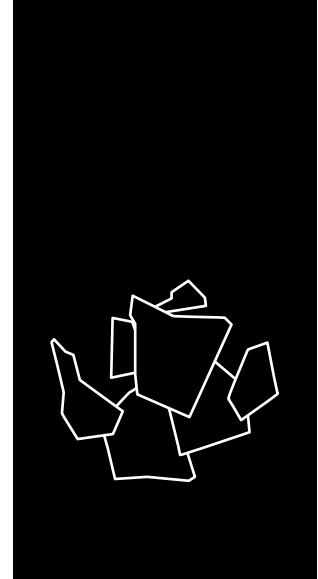





SCALA 5000 SPLIT 230 V / 50 Hz

MODULAR FLAKE ICE MACHINE SPLIT

FEATURES CARACTERÍSTICAS

- ▶ **PRODUCES COLD AND DRY FLAT FLAKES. FLAKE THICKNESS MAY BE ADJUSTED BETWEEN 1.5 mm AND 3 mm**
PRODUCE ESCAMAS PLANAS MUY FRÍAS Y SECAS. EL ESPESOR PUEDE REGULARSE ENTRE 1.5 Y 3 mm
- ▶ **BASED ON A STATIC CYLINDER WHICH IS FREE FROM SWIVEL JOINTS (HELICAL REAMER) COUPLED WITH A MILLING TOOL THAT DETACHES THE ICE WITHOUT ANY STRAINED OR FORCED MOVEMENTS**
FUNCIONAMIENTO BASADO EN UN CILINDRO ESTÁTICO SIN JUNTAS GIRATORIAS (HELICAL REAMER) Y CON UNA FRESA QUE DESPEGA EL HIELO SIN TENSIONES NI ESFUERZOS
- ▶ **THE MOST EFFICIENT EVAPORATOR OF THE MARKET, LESS ENERGY CONSUMPTION AND HIGHER ICE PRODUCTION**
EL EVAPORADOR MAS EFICIENTE DEL MERCADO, MENOR GASTO ENERGÉTICO, MAYOR PRODUCCIÓN DE HIELO
- ▶ **THERMOSTATIC EXPANSION VALVE / LIQUID SOLENOID VALVE / STOP WHEN FULL BIN STOP WITH PHOTOELECTRICAL SENSOR**
VÁLVULA DE EXPANSIÓN TERMOSTÁTICA / VÁLVULA SOLENOIDE DE LÍQUIDO / PARO POR LLENADO DE CUBA CON CÉLULA FOTOELÉCTRICA
- ▶ **ELECTRONIC STOP SYSTEM / ELECTRICAL CONTROL PANEL / DRIVE DIRECT GEAR MOTOR / MAGNETIC DRIVE PUMP / LOW WATER SAFETY DEVICE**
SISTEMA DE PARO ELECTRÓNICO / CUADRO ELÉCTRICO DE REGULACIÓN / MOTORREDUCTOR DE ATAQUE DIRECTO / BOMBA DE ARRASTRE MAGNÉTICO / SEGURIDAD ANTE FALTA DE AGUA
- ▶ **STAINLESS STEEL SOLEPLATE**
BANCADA DE ACERO INOXIDABLE
- ▶ **CONTROLLERS TO DETECT: LOW WATER LEVEL, TEMPERATURE RISE DUE TO MOTOR OVERLOAD OR FULL VAT**
CONTROLES PARA DETECTAR: FALTA DE NIVEL DE AGUA, AUMENTO DE TEMPERATURA POR SOBRESFUERZO EN EL MOTORREDUCTOR O POR LLENADO DE ALMACÉN

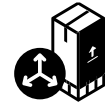

					
SCALA 5000 SPLIT 	5.500	5.000	Width 1.850 Depth 1.150 Height 1.300	Width 1.910 Depth 1.220 Height 1.475	FLAKE ICE

ACCESSORIES ACCESORIOS

OPTIONAL (NOT INCLUDED)



SALT DOSING PUMP WITH TANK
BOMBA DOSIFICADORA DE SAL CON DEPÓSITO



REMOTE SWITCH
INTERRUPTOR REMOTO



REMOTE SWITCH & WEEKLY PROGRAMMER
INTERRUPTOR REMOTO CON PROGRAMADOR SEMANAL



EXTERNAL STOP FULL BIN PHOTO CELL
SENSOR DE PARO EXTERNO POR LLENADO

RECOMMENDED BINS SILOS RECOMENDADOS



SS422 + SCALA 5000 SPLIT



SS623 + SCALA 5000 SPLIT



SS732 + SCALA 5000 SPLIT

SCALA 5000 SPLIT

RIGHT SIDE VIEW
VISTA LATERAL DERECHA

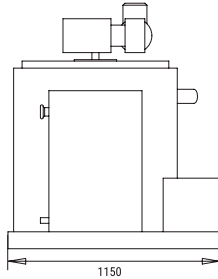

FRONTAL VIEW
VISTA FRONTAL

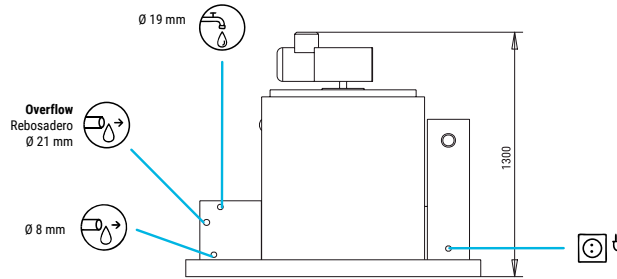

LEFT SIDE VIEW
VISTA LATERAL IZQUIERDA

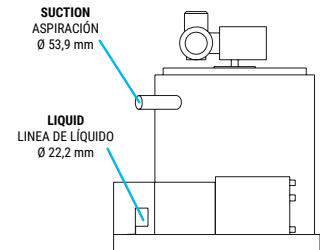

CENTRAL CROSS SECTION VIEW OF THE BASE
VISTA DE LA BASE DESDE SECCIÓN CENTRAL

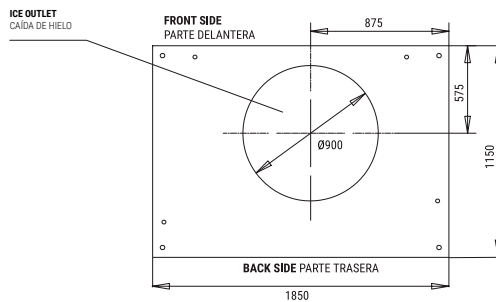

* All measurements in mm.
* Todas las cotas en mm.

OPERATING CONDITIONS CONDICIONES DE TRABAJO

PRODUCTION 50Hz PRODUCCIÓN 50 Hz

±10% V

10°C/43°C

5°C/38°C

1 bar/6 bar

V	Hz	ph
230	50	1N

°C °F	10° 50°	15° 60°	21° 70°	30° 86°
	5500	5200	4500	4200
21° 68°	5450	5000	4300	3900
32° 90°	5100	4700	4000	3600
43° 109°	4400	3900	3250	3000

MODELS MODELOS	Temp.EV. (°C)	COOLING REQUIREMENT REQUERIMIENTO FRIGORÍFICO (W) (BTu/h)	(W) 43°C	(n.) (mm²)	FUSE	100 Kg (Kw/h)	(l/h)	HEAT REJECTED (W) (BTu/h)	(Kg)	(Kg)	(m³)
SCALA 5000 S	-22	27.500 93.834	435	5 1,5	16	9,3*	208,3	- -	800	950	4,47

* WHEN INDICATED COOL REQUIREMENT IS SUPPLIED / CUANDO SE SUMINISTRA LA POTENCIA FRIGORÍFICA REQUERIDA



ITV ICE MAKERS, S.L.
POL. IND. SECTOR 13, AVDA. DELS HOSTALERS, 2
46394 RIBARROJA DE TURIA, VALENCIA, SPAIN
PHONE: +34 96 166 75 75 | FAX: +34 96 166 81 00
info@itv.es | www.itv.es



SERVICE
SERVICIO ASISTENCIA TÉCNICA
service@itv.es
Skype: ITV.Service
+34 961 667 639
8:00AM | 7:00PM



Subject to certain limitations
and exclusions. Only spare parts.
Sujeto a limitaciones y exclusiones.
Solo piezas de repuesto.



9000
9001
14000

