

SCALA 400 CO₂ SPLIT





230 V / 50 Hz

MODULARER SCHERBENEISBEREITER

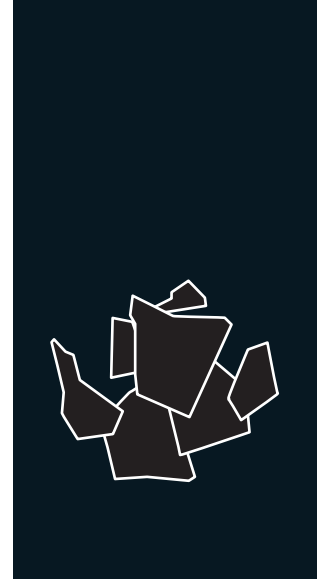
EIGENSCHAFTEN

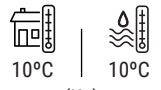
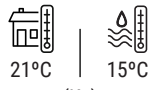
- ▶ PRODUZIERT SEHR KALTE UND TROCKENE SCHERBEN. DIE DICKE KANN ZWISCHEN 1,5 UND 3 MM REGULIERT WERDEN
- ▶ BETRIEB BASIERT AUF EINEM STATISCHEN ZYLINDER OHNE DREHGELENKE (HELICAL REAMER) ZUSAMMEN MIT EINEM FRÄSWERKZEUG, DAS DAS EIS OHNE BELASTUNG ODER ANSTRENGUNG ZERBRICHT
- ▶ DER EFFIZIENTESTE VERDAMPFER DES MARKTES, WENIGER ENERGIEVERBRAUCH UND HÖHERE EISPRODUKTION
- ▶ ELEKTRONISCHES STOP-SYSTEM / ELEKTRISCHE STEUERUNG / GETRIEBEMOTOR MIT DIREKTEM ANGRIFF / MAGNETISCHE ANTRIEBSPUMPE / NIEDRIGE WASSERSICHERHEITSVORRICHTUNG
- ▶ EDELSTAHL-SOLEPLATE
- ▶ KONTROLLEN FÜR: WASSERMANGEL, TEMPERATURERHÖHUNG DURCH ÜBERBELASTUNG DES GETRIEBEMOTORS ODER BEHÄLTERBEFÜLLUNG



	 24 H (Kg)	 10°C 10°C (Kg)	 21°C 15°C (Kg)	 (mm)	 (mm)	 SCHERBENEIS -7°C Eistemperatur
SCALA 400 CO ₂ SPLIT		450	400	Breite 1.090 Tiefe 700 Höhe 760	Breite 1.220 Tiefe 820 Höhe 915	

ZUBEHÖR

EINBEGRIFFEN



EMPFOHLEN



EMPFOHLENE VORRATSBEHÄLTER



S400 + SCALA 400 CO2 SPLIT

S500 + SCALA 400 CO2 SPLIT

SCD400 + SCALA 400 CO2 SPLIT

SCD600 + SCALA 400 CO2 SPLIT

SCD800 + SCALA 400 CO2 SPLIT

TECHNISCHE DATEN



SCALA 400 CO₂ SPLIT

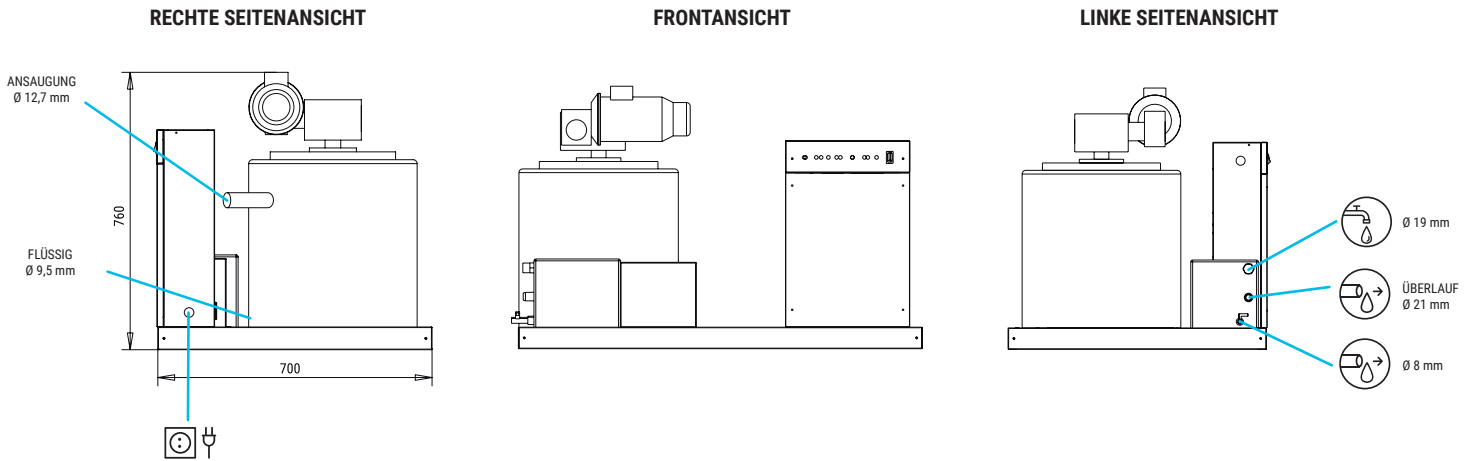

QUERSCHNITT-ANSICHT DER BASIS

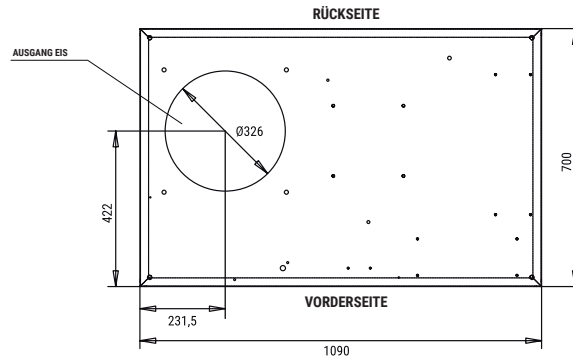

* Alle Größen in mm.

LEISTUNGEN

PRODUKTION 50Hz

R 744

24 H

1'5"-2'2 mm

24 H

3 mm

°C °F	SCALA 400 CO ₂ SPLIT			
	10° 50°	15° 60°	21° 70°	30° 86°
10°	450	420	350	310
21°	440	400	335	290
32°	410	360	300	260
43°	335	290	230	200
109°				

°C °F	SCALA 400 CO ₂ SPLIT			
	10° 50°	15° 60°	21° 70°	30° 86°
10°	419	391	326	288
21°	409	372	312	270
32°	381	335	279	242
43°	312	270	214	186
109°				

	V	Hz	ph
	230	50	1N

MODELLE

Temp.EV. (°C)	ASHRAE KONDITIONEN (W) (BTU/h)	(W) 43°C	(n.)	(mm ²)	FUSE	100 Kg (Kw/h)	(l/h)	(W) (BTU/h)	(Kg)	(Kg)	(m ³)			
SCALA 400 CO ₂ SPLIT	-22	2.200	7.507	1.425	3	1,5	16	7,5*	16,6	-	-	100	127	0,92

* WENN DIE ERFORDERLICHE KÄLTELEISTUNG VERSORGT WIRD



ITV ICE MAKERS, S.L.
POL. IND. SECTOR 13, AVDA. DELS HOSTALERS, 2
46394 RIBARROJA DE TURIA, VALENCIA, SPAIN
PHONE: +34 96 166 75 75 | FAX: +34 96 166 81 00
info@itv.es | www.itv.es



SERVICE
service@itv.es
Skype: ITV.Service
+34 961 667 639
8:00AM | 7:00PM



Auf Teile und Lohn.
Vorbehaltlich bestimmter
Einschränkungen und
Ausschlüsse.

