









SCALA 1500 SPLIT 230 V / 50-60 Hz

MODULAR FLAKE ICE MACHINE SPLIT

FEATURES CARATTERISTICHE

- ▶ **PRODUCES COLD AND DRY FLAT FLAKES. FLAKE THICKNESS MAY BE ADJUSTED BETWEEN 1.5 mm AND 3 mm**
 PRODUCE SCAGLIE PIANE MOLTO FREDDI E ASCIUTTE. LO SPESSORE È REGOLABILE DA 1.5 A 3 mm
- ▶ **BASED ON A STATIC CYLINDER WHICH IS FREE FROM SWIVEL JOINTS (HELICAL REAMER) COUPLED WITH A MILLING TOOL THAT DETACHES THE ICE WITHOUT ANY STRAINED OR FORCED MOVEMENTS**
 FUNZIONAMENTO BASATO SU UN CILINDRO STATICO SENZA GIUNTI ROTANTI (ALESATORE ELICOIDALE) E CON UNA FRESA CHE STACCA IL GHIACCIO SENZA TENSIONE O SFORZO
- ▶ **THE MOST EFFICIENT EVAPORATOR OF THE MARKET, LESS ENERGY CONSUMPTION AND HIGHER ICE PRODUCTION**
 L'EVAPORATORE PIÙ EFFICIENTE SUL MERCATO, CONSUMO ENERGETICO MINORE, MAGGIORE PRODUZIONE DI GHIACCIO
- ▶ **THERMOSTATIC EXPANSION VALVE / LIQUID SOLENOID VALVE / STOP WHEN FULL BIN STOP WITH PHOTOELECTRICAL SENSOR**
 VALVOLA DI ESPANSIONE TERMOSTATICA / VALVOLA A SOLENOIDE DEL LIQUIDO / RRESTO PER RIEMPIMENTO DELLA CISTERNA CON SENSORE FOTOELETTRICO
- ▶ **ELECTRONIC STOP SYSTEM / ELECTRICAL CONTROL PANEL / DRIVE DIRECT GEAR MOTOR / MAGNETIC DRIVE PUMP / LOW WATER SAFETY DEVICE**
 SISTEMA ELETTRONICO DI ARRESTO / PANNELLO DI CONTROLLO ELETTRICO / MOTORIDUTTORE CON TRASMISSIONE DIRETTA / POMPA A TRASCINAMENTO MAGNETICO / DISPOSITIVO DI SICUREZZA IN CASO DI MANCANZA DI ACQUA
- ▶ **STAINLESS STEEL SOLEPLATE**
 PIASTRA IN ACCIAIO INOSSIDABILE
- ▶ **CONTROLLERS TO DETECT: LOW WATER LEVEL, TEMPERATURE RISE DUE TO MOTOR OVERLOAD OR FULL VAT**
 DISPOSITIVI PER RILEVARE: MANCANZA DI ACQUA, AUMENTO DELLA TEMPERATURA A CAUSA DEL SOVRACCARICO DEL MOTORE O PER RIEMPIMENTO DELLA VASCHETTA

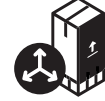

	 24 H	 10°C	 10°C	 21°C	 15°C	 (mm)	 (mm)	
SCALA 1500 SPLIT 	1.650	1.500	Width 1.050 Depth 750 Height 1.060	Width 1.150 Depth 850 Height 1.180	FLAKE ICE -7°C Ice Temperature			

ACCESSORIES ACCESSORI

INCLUSO			OPTIONAL (NON INCLUSO)					
								
WATER INLET FILTER GASKET GIUNTURA DEL FILTRO DI INGRESSO DELL'ACQUA	WATER INLET HOSE TUBO INGRESSO DELL'ACQUA	WATER OUTLET HOSE TUBO DI SCARICO	ICE DROP CHUTE TUBO DI FUORIUSCITA DEL GHIACCIO	SALT DOSING PUMP WITH TANK BOMBA DOSATORE DI SALE CON DEPOSITO	REMOTE SWITCH INTERRUTTORE REMOTO	REMOTE SWITCH & WEEKLY PROGRAMMER INTERRUTTORE REMOTO CON TIMER SETTIMANALE	EXTERNAL STOP FULL BIN PHOTO CELL SENSORE DI ARRESTO ESTERNO PER RIEMPIMENTO	

RECOMMENDED BINS SERBATOIO RACCOMANDATI



S500 + SCALA 1500 SPLIT

SCD400 + SCALA 1500 SPLIT

SCD600 + SCALA 1500 SPLIT

SCD800 + SCALA 1500 SPLIT

SS221 + SCALA 1500 SPLIT

SCALA 1500 SPLIT

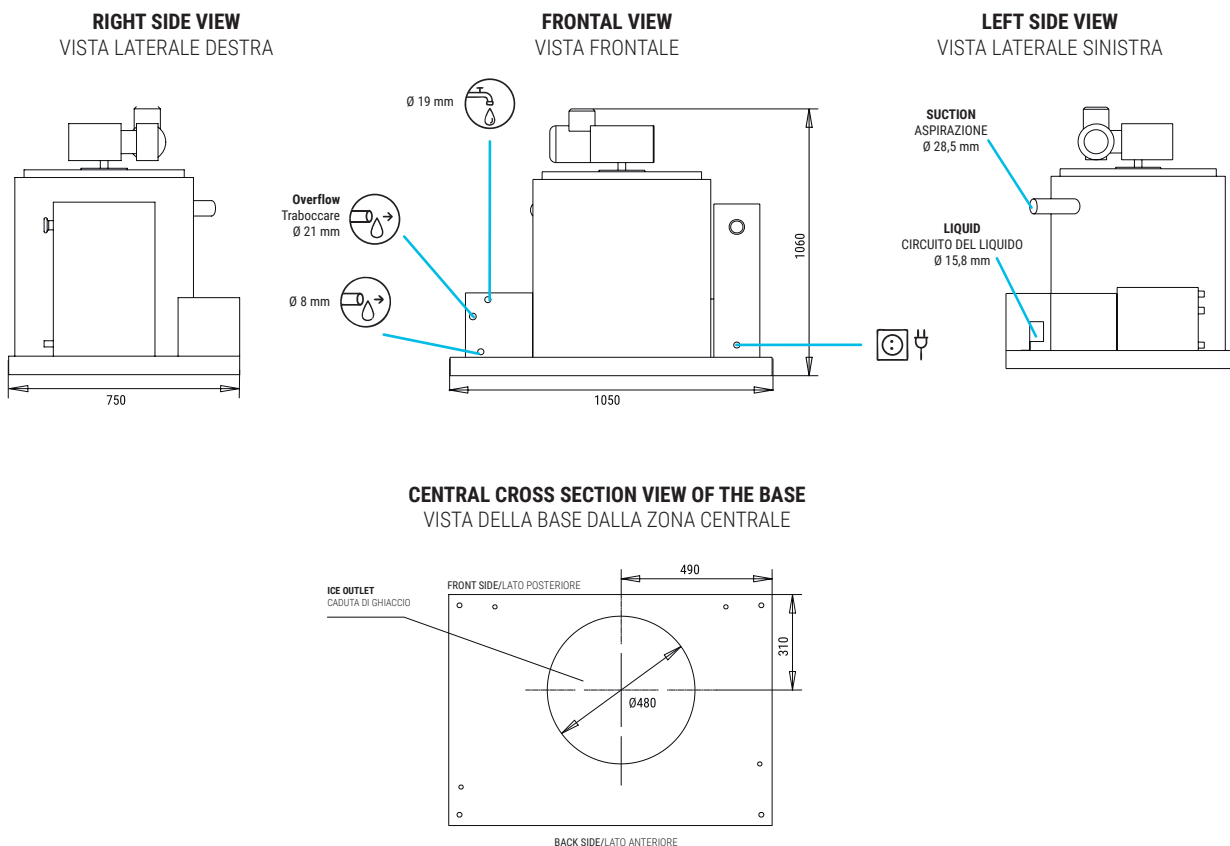

* All measurements in mm.
* Tutte le misure in mm.

OPERATING CONDITIONS CONDIZIONI PER IL FUNZIONAMENTO

PRODUCTION 50-60Hz PRODUZIONE 50-60 Hz

Icon	Value	SCALA 1500 SPLIT					SCALA 1500 SPLIT				
		10°	15°	21°	30°	10°	15°	21°	30°		
±10% V	±10% V	10°	15°	21°	30°	10°	15°	21°	30°		
10°C/43°C	10°C/43°C	50°	60°	70°	86°	50°	60°	70°	86°		
5°C/38°C	5°C/38°C	1650	1575	1350	1240	1535	1465	1256	1153		
1 bar/6 bar	1 bar/6 bar	1600	1500	1290	1190	1488	1395	1200	1107		
		1520	1400	1200	1100	1414	1302	1116	1023		
		1280	1180	950	900	1190	1097	884	837		

MODELS
MODELLI

Model	Temp.EV (°C)	COOLING REQUIREMENT (W) (BTU/h)	(W) 43°C	(n.) (mm²)	FUSE	100 Kg (Kw/h)	(l/h)	HEAT REJECTED (W) (BTU/h)	(Kg)	(Kg)	(m³)
SCALA 1500 S	-22	8.250 28.150	200	3 1,5	16	10,3*	62,5	- -	200	260	1.15

* WHEN INDICATED COOL REQUIREMENT IS SUPPLIED / QUANDO VIENE FORNITA LA POTENZA FRIGORIFERA RICHIESTA.



ITV ICE MAKERS, S.L.
POL. IND. SECTOR 13, AVDA. DELS HOSTALERS, 2
46394 RIBARROJA DE TURIA, VALENCIA, SPAIN
PHONE: +34 96 166 75 75 | FAX: +34 96 166 81 00
info@itv.es | www.itv.es



SERVICE
SERVIZIO ASSISTENZA TECNICA
service@itv.es
Skype: ITV.Service
+34 961 667 639
8:00AM | 7:00PM



Subject to certain limitations
and exclusions. Only spare parts.
Soggetta a limitazioni e revoca. Solo
parti di ricambio.

