

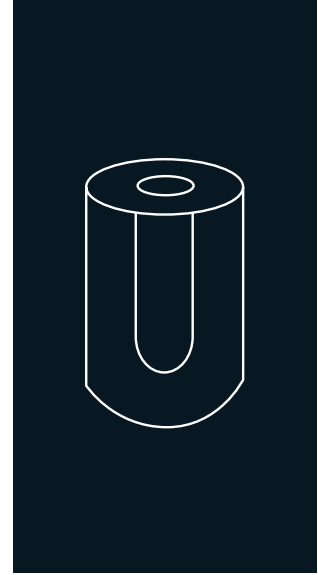











# QUASAR 40C 230 V / 50 Hz

## HOHLEISKEGELBEREITER MIT BEHÄLTER

### EIGENSCHAFTEN

- ▶ PADDELSYSTEM, DAS ES ERMÖGLICHT, EIS UNTER DEN UNGÜNSTIGSTEN BEDINGUNGEN DER WASSERQUALITÄT (HARTES WASSER) UND AN DEN WENIGER GEEIGNETEN STANDORTEN HERZUSTELLEN
- ▶ PADDELSYSTEM, DAS WASSERFILTER ÜBERFLÜSSIG MACHT UND DEREN KOSTEN VERMEIDET
- ▶ DIE BEWEGUNG DES WASSERS DANK DER PADDELS SORGT FÜR REINERES WASSER
- ▶ OHNE THERMOSTAT KONZIPIERT, VERMEIDEN SIE PROBLEME UND ERHALTEN SO VIEL EIS WIE MÖGLICH
- ▶ OHNE TIMER WIRD DAS ENDE DES EISZYKLUS UND DIE BEFÜLLUNG DES LAGERS DURCH MECHANISCHE VORRICHTUNGEN ERFASST
- ▶ EINFACHES UND ZUVERLÄSSIGES FERTIGUNGSDESIGN
- ▶ SIE ERZEUGT HOHLEISKEGEL MIT EINER GRÖßEREN OBERFLÄCHE, DIE DAS GETRÄNK SCHNELLER ABKÜHLT
- ▶ NACH INNEN ÖFFNENDE TÜR ZUR VERMEIDUNG VON UNFÄLLEN
- ▶ BELEUCHTETER EIN/AUS-SCHALTER AN DER FRONTPLATTE
- ▶ GEHÄUSE AUS ROSTFREIEM STAHL AISI 304
- ▶ TROPENTAUGLICHE MASCHINEN (KLASSE T)



	 24 H	 10°C (Kg)	 10°C (Kg)	 21°C (Kg)	 15°C (Kg)	 STOCK (Kg)	 (mm)	 (mm)	
QUASAR 40C L		38	38	12	Breite 401 Tiefe 506 Höhe 698*	Breite 500 Tiefe 605 Höhe 815	<b>QUASAR 20gr</b> <small>29 (Ø) x 42 mm (H) DURCHSCHNITTSGRÖßE</small>		
QUASAR 40C W		44	39		Höhe 698*	Höhe 815			

\* MIT FÜßEN 755

### ZUBEHÖR

#### EINBEGRIFFEN



#### EMPFOHLEN



# TECHNISCHE DATEN

## QUASAR 40C



RECHTE SEITENANSICHT

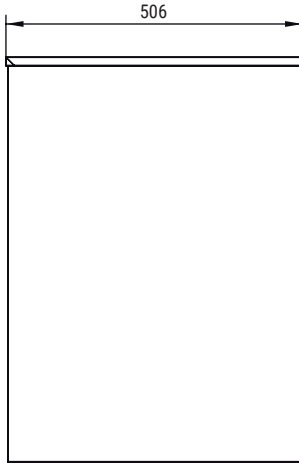

FRONTANSICHT

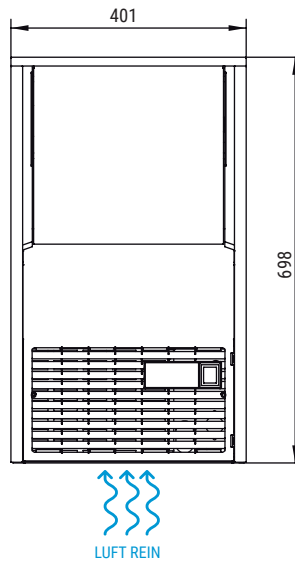

RÜCKANSICHT

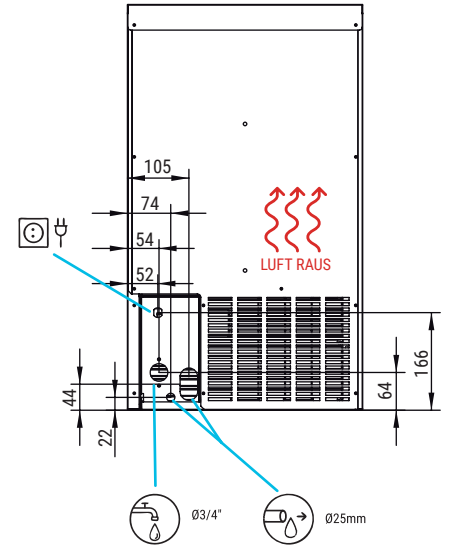

\* Alle Größen in mm.

## LEISTUNGEN

### PRODUKTION 50Hz

±10% V

5°C/43°C

5°C/35°C

1 bar/6 bar

25 Eiskegel/Zyklus

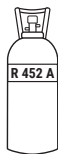

V	Hz	ph
230	50	1N

QUASAR 40C LUFTGEKÜHLT

°C °F	10° 50°	15° 60°	21° 70°	30° 86°
	10° 50°	38	35	33
21° 68°	40	38	35	33
32° 90°	32	29	27	24
43° 109°	22	18	15	13

QUASAR 40C WASSERGEKÜHLT

°C °F	10° 50°	15° 60°	21° 70°	30° 86°
	10° 50°	44	41	38
21° 68°	42	39	36	33
32° 90°	39	36	34	31
43° 109°	37	34	32	29

## MODELLE

QUASAR 40C L

QUASAR 40C W

	ASHRAE KONDITIONEN (W) (BTU/h)	(W) 43°C	(n.) (mm <sup>2</sup> )	SICHERUNG	100 Kg (Kwh)	(l/h)	WÄRME (W) (BTU/h)	(Kg)	(Kg)	(m <sup>3</sup> )
QUASAR 40C L	966 3.296	421	3 1,5	10	20	5,5	731 2.494	40	45	0,25
QUASAR 40C W	966 3.296	306	3 1,5	10	18,5	24,2	731 2.494	40	45	0,25



ITV ICE MAKERS, S.L.  
POL. IND. SECTOR 13, AVDA. DELS HOSTALERS, 2  
46394 RIBARROJA DE TURIA, VALENCIA, SPAIN  
PHONE: +34 96 166 75 75 | FAX: +34 96 166 81 00  
info@itv.es | www.itv.es



SERVICE  
service@itv.es  
Skype: ITV.Service  
+34 961 667 639  
8:00AM | 7:00PM



Auf Teile und Lohn.  
Vorbehaltlich bestimmter  
Einschränkungen und  
Ausschlüsse.



9000  
9001  
14000

