

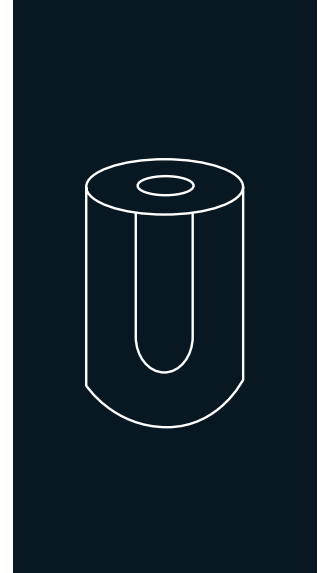











# QUASAR 20C 230 V / 50 Hz

## HOHLEISKEGELBEREITER MIT BEHÄLTER

### EIGENSCHAFTEN

- ▶ PADDELSYSTEM, DAS ES ERMÖGLICHT, EIS UNTER DEN UNGÜNSTIGSTEN BEDINGUNGEN DER WASSERQUALITÄT (HARTES WASSER) UND AN DEN WENIGER GEEIGNETEN STANDORTEN HERZUSTELLEN
- ▶ PADDELSYSTEM, DAS WASSERFILTER ÜBERFLÜSSIG MACHT UND DEREN KOSTEN VERMEIDET
- ▶ DIE BEWEGUNG DES WASSERS DANK DER PADDELS SORGT FÜR REINERES WASSER
- ▶ OHNE THERMOSTAT KONZIPIERT, VERMEIDEN SIE PROBLEME UND ERHALTEN SO VIEL EIS WIE MÖGLICH
- ▶ OHNE TIMER WIRD DAS ENDE DES EISZYKLUS UND DIE BEFÜLLUNG DES LAGERS DURCH MECHANISCHE VORRICHTUNGEN ERFASST
- ▶ EINFACHES UND ZUVERLÄSSIGES FERTIGUNGSDESIGN
- ▶ SIE ERZEUGT HOHLEISKEGEL MIT EINER GRÖßEREN OBERFLÄCHE, DIE DAS GETRÄNK SCHNELLER ABKÜHLT
- ▶ NACH INNEN ÖFFNENDE TÜR ZUR VERMEIDUNG VON UNFÄLLEN
- ▶ BELEUCHTETER EIN/AUS-SCHALTER AN DER FRONTPLATTE
- ▶ GEHÄUSE AUS ROSTFREIEM STAHL AISI 304
- ▶ TROPENTAUGLICHE MASCHINEN (KLASSE T)



	 24 H	 10°C (Kg)	 10°C (Kg)	 21°C (Kg)	 15°C (Kg)	 STOCK (Kg)	 (mm)	 (mm)	
QUASAR 20C L		24	22	6	Breite 401	Breite 495	<b>QUASAR 20gr</b> 29 (Ø) x 42 mm (H) DURCHSCHNITTSGRÖßE		
QUASAR 20C W		27	24		Tiefe 506	Tiefe 605			
					Höhe 643*	Höhe 760			

\* MIT FÜßEN 700

### ZUBEHÖR

#### EINBEGRIFFEN



#### EMPFOHLEN



# TECHNISCHE DATEN

## QUASAR 20C



RECHTE SEITENANSICHT



FRONTANSICHT

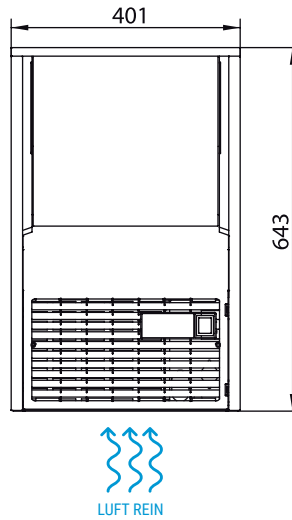

RÜCKANSICHT

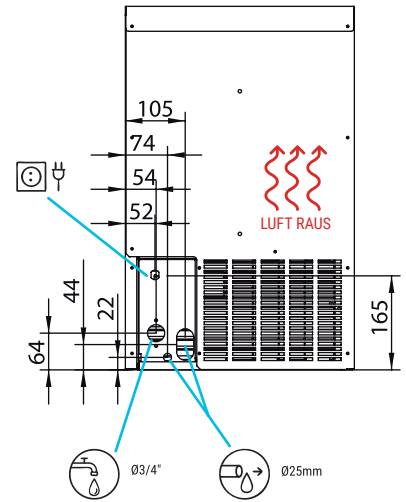

\* Alle Größen in mm.

# LEISTUNGEN

## PRODUKTION 50Hz

±10% V

5°C/43°C

5°C/35°C

1 bar/6 bar

15 Eiskegel/Zyklus

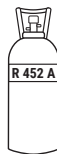

V	Hz	ph
230	50	1N

QUASAR 20C LUFTGEKÜHLT

	°C			
	10°	15°	21°	30°
50°	24	23	22	20
68°	23	22	20	19
90°	19	18	15	14
109°	14	12	9	7

QUASAR 20C WASSERGEKÜHLT

	°C			
	10°	15°	21°	30°
50°	27	25	23	21
68°	26	24	22	20
90°	25	23	21	19
109°	24	22	21	19

# MODELLE

QUASAR 20C L

QUASAR 20C W

	ASHRAE KONDITIONEN (W) (BTU/h)	(W) 43°C	(n.) (mm²)	SICHERUNG	100 Kg (Kwh)	(l/h)	WÄRME (W) (BTU/h)	(Kg)	(Kg)	(m³)
QUASAR 20C L	758 2.586	287	3 1,5	10	22,8	4,2	530 1.808	36	40	0,23
QUASAR 20C W	758 2.586	189	3 1,5	10	18	16,9	530 1.808	36	40	0,23



ITV ICE MAKERS, S.L.  
POL. IND. SECTOR 13, AVDA. DELS HOSTALERS, 2  
46394 RIBARROJA DE TURIA, VALENCIA, SPAIN  
PHONE: +34 96 166 75 75 | FAX: +34 96 166 81 00  
info@itv.es | www.itv.es



SERVICE  
service@itv.es  
Skype: ITV.Service  
+34 961 667 639  
8:00AM | 7:00PM



Auf Teile und Lohn.  
Vorbehaltlich bestimmter  
Einschränkungen und  
Ausschlüsse.



9000  
9001  
14000

