

ICE QUEEN F 300

230 V / 50 Hz







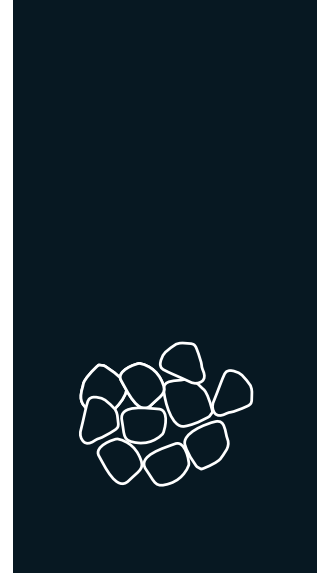

MODULAR CHIP ICE MACHINE

FEATURES CARACTERÍSTICAS

- ▶ **PRODUCE CHIP ICE**
PRODUCE HIELO CHIP
- ▶ **HIGH EVAPORATOR EFFICIENCY: LOWER ENERGY CONSUMPTION AND HIGHER ICE PRODUCTION**
EVAPORADOR DE ALTA EFICIENCIA: MENOR GASTO ENERGÉTICO, MAYOR PRODUCCIÓN DE HIELO
- ▶ **AUTODIAGNOSIS LED LIGHTS SIGNALING OPERATION STATUS & ALERTS**
AUTODIAGNOSIS CON SEÑALIZACIÓN DE LEDS SOBRE EL FUNCIONAMIENTO Y ALERTAS
- ▶ **ELECTRONIC CONTROL. ON/OFF LIGHTED SWITCH IN FRONT PANEL**
CONTROL ELECTRÓNICO. BOTÓN ENCENDIDO/APAGADO LUMINOSO EN PANEL FRONTAL
- ▶ **STAINLESS STEEL AUGER WITH RESILIENT COATING TO MAXIMIZE LIFESPAN**
HUSILLO DE ACERO INOXIDABLE CON POSTERIOR TRATAMIENTO SUPERFICIAL PARA AUMENTAR SU VIDA ÚTIL
- ▶ **POWERFUL MOTOR GEAR**
POTENTE MOTOR REDUCTOR
- ▶ **AISI 304 STAINLESS STEEL BODY**
CARROCERÍA EN ACERO INOXIDABLE AISI 304
- ▶ **OPTICAL PINPOINT CONTROL SYSTEM TO SET ICE STOCK LEVEL. ICE DROPS OUT THROUGH THE OPENING ON THE BOTTOM OF THE UNIT**
REGULACIÓN DEL STOCK DE HIELO MEDIANTE UN SISTEMA DE CONTROL ÓPTICO DE PRECISIÓN. EL HIELO SALE POR UNA ABERTURA EN LA PARTE INFERIOR DE LA UNIDAD
- ▶ **TROPICALIZED MACHINES (T CLASS)**
MÁQUINAS TROPICALIZADAS (CLASE T)

THE INSTALLATION OF AN ANTI-SCALE FILTER AND PERIODIC CLEANING ARE ADVISED IN AREAS WITH MEDIUM OR HIGH LIMESCALE CONTENT (HARD WATER)
SE ACONSEJA LA INSTALACIÓN DE UN FILTRO ANTICAL Y LIMPIEZA PERIÓDICA EN CASO DE AGUAS CON CONTENIDO EN CAL MEDIO O ALTO (AGUAS DURAS)



	 24 H	 10°C (Kg)	 10°C (Kg)	 21°C (Kg)	 15°C (Kg)	 (mm)	 (mm)
IQ F 300 A		-	325	Width 559	Depth 622	Width 636	Depth 695
IQ F 300 W		-	-	Height 712	Height 835		



COMPACT CHIP ICE
20% RESIDUAL WATER CONTENT

ACCESSORIES ACCESORIOS

INCLUDED



WATER INLET FILTER GASKET
JUNTA DE FILTRO DE ENTRADA DE AGUA

WATER INLET HOSE
MANGUERA DE ENTRADA DE AGUA

WATER OUTLET HOSE
MANGUERA DE DESAGÜE

NOT INCLUDED (OPTIONAL)



LARGE SCOOP
PALA GRANDE

ANTI-LIMESCALE FILTER
FILTRO ANTICAL

PARTICLE FILTER
FILTRO ANTIPARTÍCULAS

RECOMMENDED BINS DEPÓSITOS RECOMENDADOS



S160 + IQ F 300

S220 + IQ F 300

S350 + IQ F 300

S400 + IQ F 300

S500 + IQ F 300

SCS150 + IQ F 300

SCS300 + IQ F 300

SCD400 + IQ F 300

SCD600 + IQ F 300

SCD800 + IQ F 300

ICE QUEEN F 300

LEFT SIDE VIEW
VISTA LATERAL IZQUIERDA

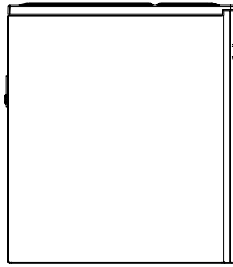

FRONTAL VIEW
VISTA FRONTAL

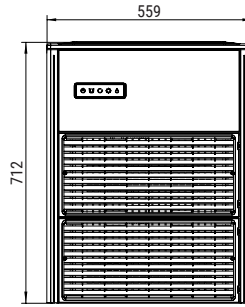

RIGHT SIDE VIEW
VISTA LATERAL DERECHA

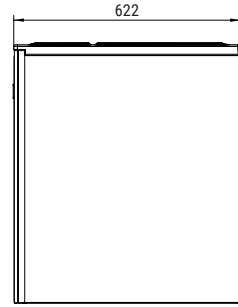

REAR VIEW
VISTA TRASERA

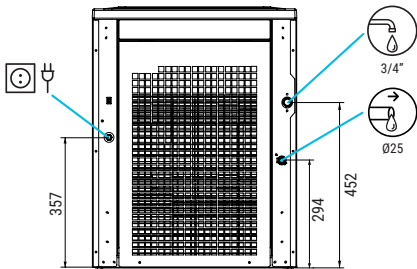

CENTRAL CROSS SECTION
VIEW OF THE BASE
VISTA DE LA BASE DESDE
SECCIÓN CENTRAL

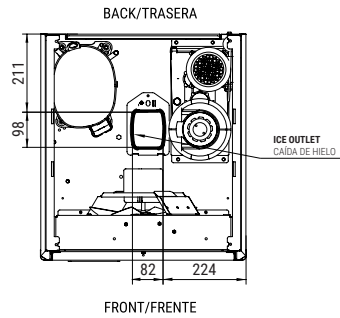

* All measurements in mm.
* Todas las cotas en mm.

OPERATING CONDITIONS CONDICIONES DE TRABAJO

PRODUCTION 50Hz PRODUCCIÓN 50 Hz

±10% V

10°C/43°C

5°C/38°C

1 bar/6 bar

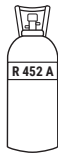

V	Hz	ph
230	50	1N

IQ F 300 AIR COOLED

°C / °F	10° / 50°	15° / 60°	21° / 70°	30° / 86°
10° / 50°	-	-	-	-
21° / 68°	-	325	-	-
32° / 90°	-	-	-	-
43° / 109°	-	-	-	-

IQ F 300 WATER COOLED

°C / °F	10° / 50°	15° / 60°	21° / 70°	30° / 86°
10° / 50°	-	-	-	-
21° / 68°	-	-	-	-
32° / 90°	-	-	-	-
43° / 109°	-	-	-	-

MODELS
MODELOS

IQ F 300 A

IQ F 300 W

Temp. Ev. (°C)	ASHRAE CONDITIONS (W) (BTU/h)	(W) (BTU/h)	(W) 43°C	(n.) (mm ²)	FUSE	100 Kg (Kwh)	(l/h)	HEAT REJECTED (W) (BTU/h)	(Kg)	(Kg)	(m ³)		
-15°	3.355	11.448	1.360	3	1,5	16	8,6	13,5	2.214	7.554	84	93	0,38
-	-	-	-	-	-	-	-	-	-	-	-	-	-



ITV ICE MAKERS, S.L.
POL. IND. SECTOR 13, AVDA. DELS HOSTALERS, 2
46394 RIBARROJA DE TURIA, VALENCIA, SPAIN
PHONE: +34 96 166 75 75 | FAX: +34 96 166 81 00
info@itv.es | www.itv.es



SERVICE
SERVICIO ASISTENCIA TÉCNICA
service@itv.es
Skype: ITV.Service
+34 961 667 639
8:00AM | 7:00PM



Subject to certain limitations and exclusions. Only spare parts.
Sujeto a limitaciones y exclusiones. Solo piezas de repuesto.

