

# BIN SCD800

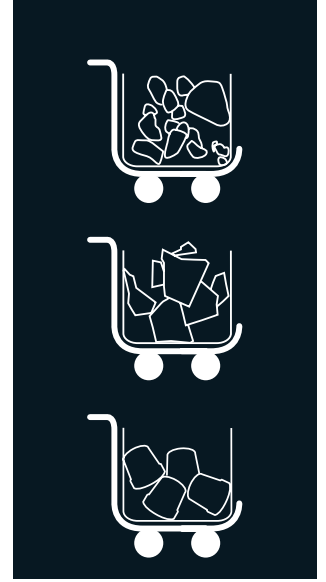









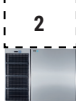



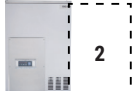





## ICE BIN WITH CARTS FOR MODULAR MACHINES

### FEATURES CARATTERISTICHE

- ▶ **ICE BIN CAPACITY OF 812 KG (CART CAPACITY NOT INCLUDED)**  
SERBATOIO PER GHIACCIO CON CAPACITÀ DI 812 KG (CAPACITÀ DEL CARRELLO NON INCLUSA)
- ▶ **AISI 304 STAINLESS STEEL BIN**  
SERBATOIO DI ACCIAIO INOSSIDABILE QUALITÀ AISI 304
- ▶ **HARD SANITARY POLYETHYLENE VAT, RESISTANT TO BLOWS, AND SCRATCHES**  
CISTERNA INTERNA DI POLIETILENE SANITARIO DI ELEVATA DUREZZA, RESISTENTE AD URTI E ATTRITI
- ▶ **EASY CLEANING DESIGN®: SEAMLESS ONE-PIECE VAT WITH ROUNDED CORNERS, AVOIDING POSSIBLE DIRTY POINTS AND FACILITATING CLEANING**  
EASY CLEANING DESIGN®: CISTERNA INTERNA SENZA GIUNZIONI, IN UN UNICO PEZZO, CON ANGOLI ARROTONDATI PER ELIMINARE EVENTUALI PUNTI DI SPORCIZIA E FACILITARE LA PULIZIA
- ▶ **DRAINAGE SYSTEM THAT COLLECTS AND DRIVES THE WATER TO THE DRAIN KEEPING THE BIN AND FLOOR CLEAN & DRY**  
SISTEMA DI DRENAGGIO CHE RACCOGLIE E CONDUCE L'ACQUA ALLO SCARICO MANTENENDO IL SERBATOIO E IL PAVIMENTO PULITI E ASCIUTTI
- ▶ **LARGE CAPACITY EASY CART®, UP TO 112 KG OF ICE (70 KG WITH BUCKETS); ERGONOMIC, EASY TO MOVE WITH LITTLE EFFORT**  
EASY CART® CON ELEVATA CAPACITÀ, FINO A 112 KG DI GHIACCIO (70 KG CON CESTELLI) ED ERGONOMIC, FACILE DA SPOSTARE CON IL MINIMO SFORZO
- ▶ **EASY CART® HAS A BRAKING AND DRAINAGE SYSTEM**  
EASY CART® DISPONE DI SISTEMA FRENANTE E SCARICO
- ▶ **EASY CART® IS MADE OF SANITARY POLYETHYLENE, WITH SMOOTH SURFACE TO FACILITATE CLEANING. IT INCLUDES A COVER TO PREVENT DIRT FROM CONTAMINATING THE ICE**  
EASY CART® IN POLIETILENE SANITARIO, SENZA RUGOSITÀ PER FACILITARE LA PULIZIA. INCLUDE COPERCHIO PER EVITARE CHE LA POLVERE CONTAMINI IL GHIACCIO
- ▶ **BUCKETS FOR DISTRIBUTING ICE QUICKLY AND EFFORTLESSLY CAN BE INCLUDED**  
SI POSSONO INCLUDERE CESTELLI PER DISTRIBUIRE IL GHIACCIO RAPIDAMENTE E SENZA SFORZO



### RECOMMENDED MACHINES MACCHINE RACCOMANDATI

	MDP150/MR400/MP	SPIKA	QUASAR	ICE QUEEN	SCALA
<b>RECOMMENDED RACCOMANDATO</b>	  2 1/2 MR400	 2 MS220   2 MS410		 2 1/2 IQ400  2 1/2 IQ550  2 1/2 IQ550 SPLIT  IQ1100  IQ1100 SPLIT	 SCALA 400 SCALA 400 SPLIT  SCALA 600 SCALA 600 SPLIT  SCALA 1000/1500/2000/3000 SPLIT
<b>NOT RECOMMENDED NO RACCOMANDATO</b>	 15%  2 1/2 MDP150  2 1/2 MP145	 MS220  MS300 SLIM  MS410		 2 1/2 IQ150  2 1/2 IQ200  2 IQ1100 SPLIT	 SCALA 1000



**RIGHT SIDE VIEW**  
VISTA LATERALE SINISTRA

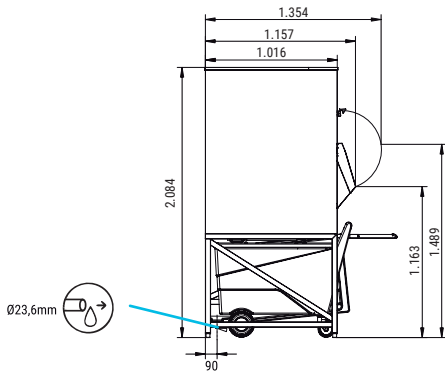

**FRONTAL VIEW**  
VISTA FRONTALE

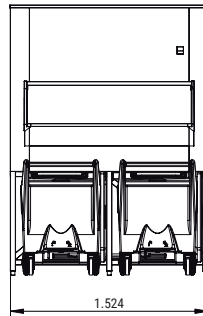

**REAR VIEW**  
VISTA POSTERIORE

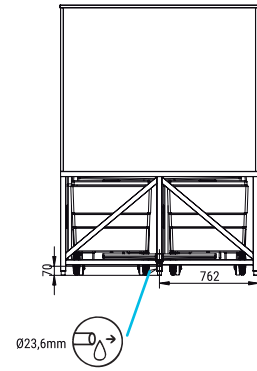

**UPPER VIEW**  
VISTA SUPERIORE

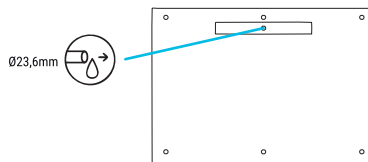

\* All measurements in mm.  
\* Tutte le misure in mm.

**ACCESSORIES ACCESSORI**

**INCLUDED**



**WATER OUTLET HOSE**  
TUBO DI SCARICO



**LARGE SCOOP**  
PALETTA GRANDE



**ICE PADDLE**  
PALA CON MANICO LUNGO



**ICE PADDLE SUPPORT**  
SUPPORTO PER LA PALA

**NON INCLUSO (OPTIONAL)**



**BUCKETS**  
CESTELLI

**MODELS**  
MODELLI



BIN SCD800

812

650

1.036

Width 1.524  
Depth 1.016  
Height 2.084

175

Width 1.630  
Depth 1.240  
Height 2.240

276

4,53

\*WITHOUT DOOR. NESSUNA PORTA



ITV ICE MAKERS, S.L.  
POL. IND. SECTOR 13, AVDA. DELS HOSTALERS, 2  
46394 RIBARROJA DE TURIA, VALENCIA, SPAIN  
PHONE: +34 96 166 75 75 | FAX: +34 96 166 81 00  
info@itv.es | www.itv.es



SERVICE  
SERVIZIO ASSISTENZA TECNICA  
service@itv.es  
Skype: ITV.Service  
+34 961 667 639  
8:00AM | 7:00PM



Subject to certain limitations  
and exclusions. Only spare parts.  
Soggetta a limitazioni e revoca. Solo  
parti di ricambio.

