

BIN SCD400

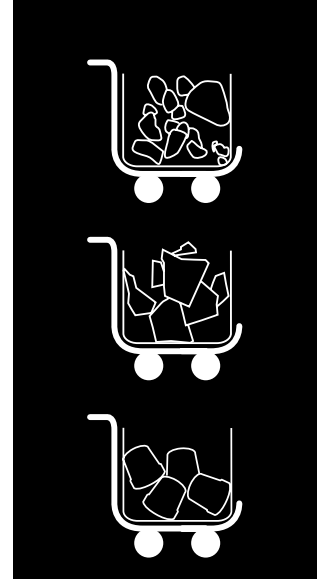









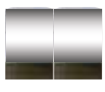









ICE BIN WITH CARTS FOR MODULAR MACHINES

FEATURES CARATTERISTICHE

- ▶ **ICE BIN CAPACITY OF 413 KG (CART CAPACITY NOT INCLUDED)**
SERBATOIO PER GHIACCIO CON CAPACITÀ DI 413 KG (CAPACITÀ DEL CARRELLO NON INCLUSA)
- ▶ **AISI 304 STAINLESS STEEL BIN**
SERBATOIO DI ACCIAIO INOSSIDABILE QUALITÀ AISI 304
- ▶ **HARD SANITARY POLYETHYLENE VAT, RESISTANT TO BLOWS, AND SCRATCHES**
CISTERNA INTERNA DI POLIETILENE SANITARIO DI ELEVATA DUREZZA, RESISTENTE AD URTI E ATTRITI
- ▶ **EASY CLEANING DESIGN®: SEAMLESS ONE-PIECE VAT WITH ROUNDED CORNERS, AVOIDING POSSIBLE DIRTY POINTS AND FACILITATING CLEANING**
EASY CLEANING DESIGN®: CISTERNA INTERNA SENZA GIUNZIONI, IN UN UNICO PEZZO, CON ANGOLI ARROTONDATI PER ELIMINARE EVENTUALI PUNTI DI SPORCIZIA E FACILITARE LA PULIZIA
- ▶ **DRAINAGE SYSTEM THAT COLLECTS AND DRIVES THE WATER TO THE DRAIN KEEPING THE BIN AND FLOOR CLEAN & DRY**
SISTEMA DI DRENAGGIO CHE RACCOGLIE E CONDUCE L'ACQUA ALLO SCARICO MANTENENDO IL SERBATOIO E IL PAVIMENTO PULITI E ASCIUTTI
- ▶ **LARGE CAPACITY EASY CART®, UP TO 112 KG OF ICE (70 KG WITH BUCKETS); ERGONOMIC, EASY TO MOVE WITH LITTLE EFFORT**
EASY CART® CON ELEVATA CAPACITÀ, FINO A 112 KG DI GHIACCIO (70 KG CON CESTELLI) ED ERGONOMIC, FACILE DA SPOSTARE CON IL MINIMO SFORZO
- ▶ **EASY CART® HAS A BRAKING AND DRAINAGE SYSTEM**
EASY CART® DISPONE DI SISTEMA FRENANTE E SCARICO
- ▶ **EASY CART® IS MADE OF SANITARY POLYETHYLENE, WITH SMOOTH SURFACE TO FACILITATE CLEANING. IT INCLUDES A COVER TO PREVENT DIRT FROM CONTAMINATING THE ICE**
EASY CART® IN POLIETILENE SANITARIO, SENZA RUGOSITÀ PER FACILITARE LA PULIZIA. INCLUDE COPERCHIO PER EVITARE CHE LA POLVERE CONTAMINI IL GHIACCIO
- ▶ **BUCKETS FOR DISTRIBUTING ICE QUICKLY AND EFFORTLESSLY CAN BE INCLUDED**
SI POSSONO INCLUDERE CESTELLI PER DISTRIBUIRE IL GHIACCIO RAPIDAMENTE E SENZA SFORZO



RECOMMENDED MACHINES MACCHINE RACCOMANDATI

	MDP150/MR400/MP	SPIKA	QUASAR	ICE QUEEN	SCALA
RECOMMENDED RACCOMANDATO	 2 MDP150 MR400  2 MP145	 1/2 MS220  1/2 MS410  MS300 SLIM		 1/2 IQ200  1/2 IQ400  1/2 IQ550  IQ550 SPLIT  IQ850 C02 SPLIT  IQ1100  IQ1100 SPLIT	 SCALA 400 SCALA 400 SPLIT  SCALA 600 SCALA 600 SPLIT  SCALA 1000/1500/2000/3000 SPLIT
NOT RECOMMENDED NO RACCOMANDATO	 MDP150  MP145		 1/2 IQ150  2 IQ550 SPLIT  2 IQ850 C02SPLIT	 SCALA 1000	



BIN SCD400

RIGHT SIDE VIEW
VISTA LATERALE SINISTRA

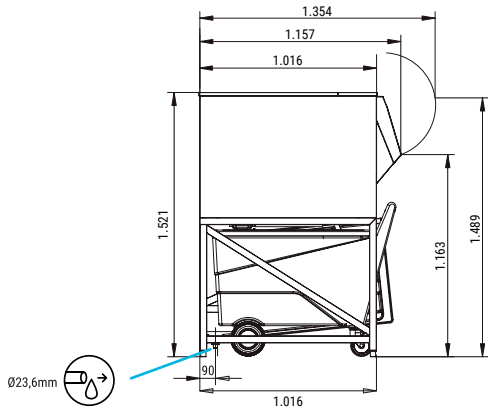

FRONTAL VIEW
VISTA FRONTALE

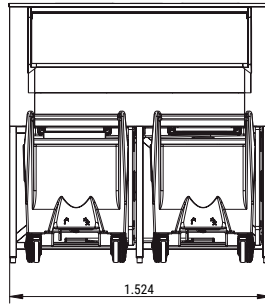

REAR VIEW
VISTA POSTERIORE

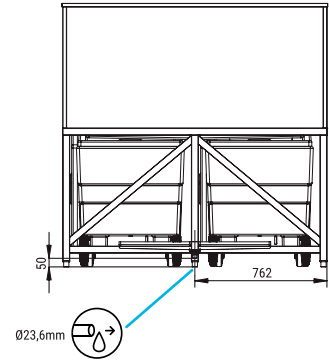

UPPER VIEW
VISTA SUPERIORE

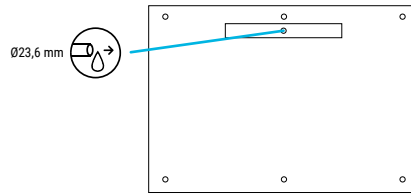

* All measurements in mm.
* Tutte le misure in mm.

ACCESSORIES ACCESSORI

INCLUDED



WATER OUTLET HOSE
TUBO DI SCARICO



LARGE SCOOP
PALETTA GRANDE



ICE PADDLE
PALA CON MANICO LUNGO











ICE PADDLE SUPPORT
SUPPORTO PER LA PALA

NON INCLUSO (OPTIONAL)



BUCKETS
CESTELLI

MODELS
MODELLI

	 (Kg)	 (Kg)	 (Kg)	 (mm)	 (Kg)	 (mm)	 (Kg)	 (m³)
BIN SCD400	413	330	637	Width 1.524 Depth 1.016* Height 1.520	140	Width 1.630 Depth 1.240 Height 1.660	235	3,36

*WITHOUT DOOR. CON SPORTELLO



ITV ICE MAKERS, S.L.
POL. IND. SECTOR 13, AVDA. DELS HOSTALERS, 2
46394 RIBARROJA DE TURIA, VALENCIA, SPAIN
PHONE: +34 96 166 75 75 | FAX: +34 96 166 81 00
info@itv.es | www.itv.es



SERVICE
SERVIZIO ASSISTENZA TECNICA
service@itv.es
Skype: ITV.Service
+34 961 667 639
8:00AM | 7:00PM



Subject to certain limitations
and exclusions. Only spare parts.
Soggetta a limitazioni e revoca. Solo
parti di ricambio.

