

BIN S400

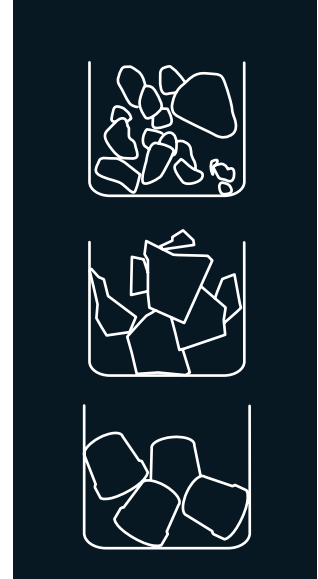









ICE BIN FOR MODULAR ICE MACHINES

FEATURES CARATTERISTICHE

- ▶ **ICE BIN CAPACITY OF 390 KG**
SERBATOIO PER GHIACCIO CON CAPACITÀ DI 390 KG
- ▶ **AISI 304 STAINLESS STEEL BINS**
SERBATOIO DI ACCIAIO INOSSIDABILE QUALITÀ AISI 304
- ▶ **VERY HARD SANITARY POLYETHYLENE VAT, RESISTANT TO BLOWS, AND SCRATCHES**
CISTERNA INTERNA DI POLIETILENE SANITARIO DI ELEVATA DUREZZA, RESISTENTE AD URTI E ATTRITI
- ▶ **EASY CLEANING DESIGN®: SEAMLESS ONE-PIECE VAT WITH ROUNDED CORNERS, AVOIDING POSSIBLE DIRTY POINTS AND FACILITATING CLEANING**
EASY CLEANING DESIGN®: CISTERNA INTERNA SENZA GIUNZIONI, IN UN UNICO PEZZO, CON ANGOLI ARROTONDATI PER ELIMINARE EVENTUALI PUNTI DI SPORCIZIA E FACILITARE LA PULIZIA
- ▶ **DRAINAGE SYSTEM THAT COLLECTS AND DRIVES THE WATER TO THE DRAIN KEEPING THE BIN CLEAN & DRY**
SISTEMA DI DRENAGGIO CHE RACCOGLIE E CONDUCE L'ACQUA ALLO SCARICO MANTENENDO IL SERBATOIO E IL PAVIMENTO PULITI E ASCIUTTI

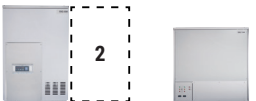

RECOMMENDED MACHINES MACCHINE RACCOMANDATI

	MDP150/MR400/MP	SPIKA	QUASAR	ICE QUEEN	SCALA
  RECOMMENDED RACCOMANDATO	 2 MDP150	 1½ MS220		 2 IQ150 2 IQ200	 SCALA 400 SCALA 400 SPLIT
		 MS300 SLIM		 IQ400 IQ550	 1½ IQ550 SPLIT
		 1½ MS410		 1½ IQ850 CO2 SPLIT IQ1100 SPLIT	

  15%
NOT RECOMMENDED NO RACCOMANDATO

- 
MDP150
- 
MP145
- 
MR400

- 
IQ150
- 
IQ200

BIN S400

RIGHT SIDE VIEW
VISTA LATERALE SINISTRA

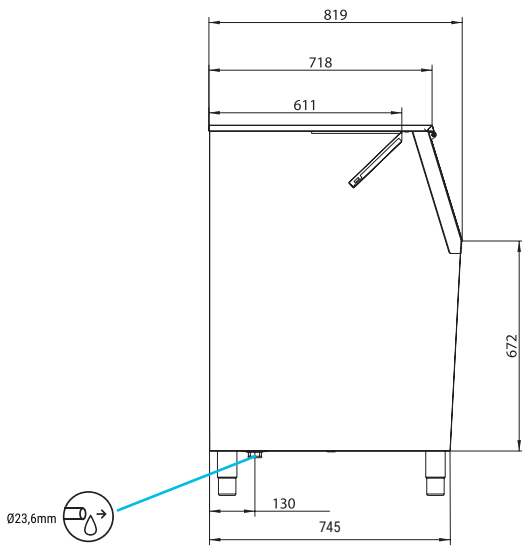

FRONTAL VIEW
VISTA FRONTALE

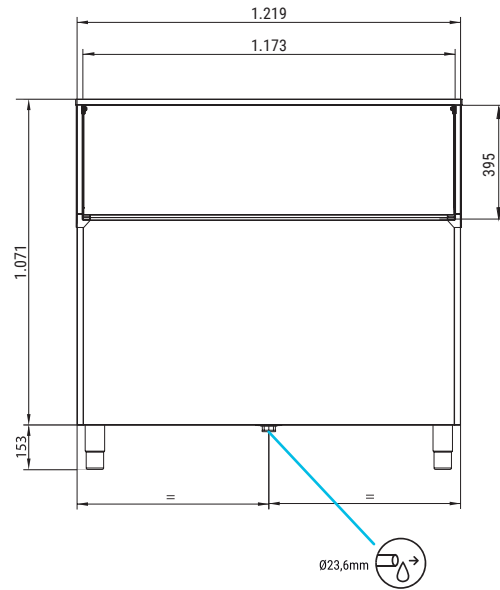

* All measurements in mm.
* Tutte le misure in mm.

ACCESSORIES ACCESSORI

INCLUSO



4 HEIGHT ADJUSTABLE LEG KIT
KIT 4 PIEDINI ALTEZZA REGOLABILE



LARGE SCOOP
PALETTA GRANDE



WATER OUTLET HOSE
TUBO DI SCARICO



DRAINAGE ELBOW
CURVA DI SCARICO



(m³)

BIN S400

390

312

Width 1.219
Depth 819
Height* 1.071

75

Width 1.300
Depth 890
Height 1.210

97

1,40

*1.224 mm with legs
*1.224 mm con piedini



ITV ICE MAKERS, S.L.
POL. IND. SECTOR 13, AVDA. DELS HOSTALERS, 2
46394 RIBARROJA DE TURIA, VALENCIA, SPAIN
PHONE: +34 96 166 75 75 | FAX: +34 96 166 81 00
info@itv.es | www.itv.es



SERVICE
SERVIZIO ASSISTENZA TECNICA
service@itv.es
Skype: ITV.Service
+34 961 667 639
8:00AM | 7:00PM



Subject to certain limitations
and exclusions. Only spare parts.
Soggetta a limitazioni e revoca. Solo
parti di ricambio.

