

SPIKA NG90









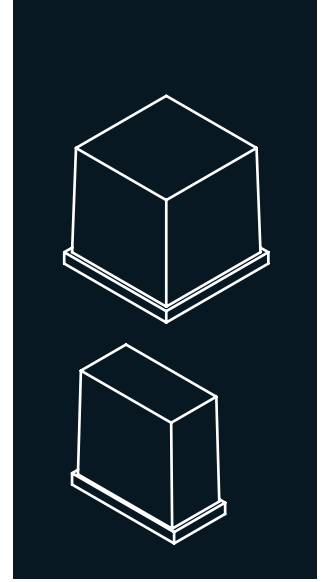



230 V / 50 Hz

EISWÜRFELBEREITER MIT BEHÄLTER

EIGENSCHAFTEN

- ▶ PRODUZIERT HALBE UND VOLLE EISWÜRFEL
- ▶ SMART FRONT VENTILATION SYSTEM (SFVS). FRONTALE VENTILATION ERMÖGLICHT EINE UNTERBAU-INSTALLATION DES GERÄTS. VÖLLIG EINBAUFÄHIG
- ▶ REINIGUNGSSCHALTER: SCHALTET DAS KÜHLSYSTEM WÄHREND DES ENTKALKUNGSVORGANGES AUS (CALCLIN ODER ÄHNLICH)
- ▶ EASI: EINFACHER ZUGANG FÜR SERVICE & INSTALLATION. ALLE PANELS KÖNNEN SEPARAT DEMONTIERT WERDEN
- ▶ BELEUCHTETER AN/AUS WIPPSCHALTER AUF FRONTPANEL
- ▶ HÖHENVERSTELLBARE FÜßE VON 105 MM BIS 155 MM
- ▶ STIF: STRONG INOX FABRICATION. STARKE INOX-HERSTELLUNG. FESTE STRUKTUR DURCH 4 INTERNE STAHLSÄULEN. KÖRPER AUS EDELSTAHL AISI 304
- ▶ STÄRKSTES BEHÄLTERTÜRÖFFNUNGSSYSTEM AUF DEM MARKT, ITV PATENTIERT. TÜR AUS EDELSTAHL AISI 304



	 24 H	 10°C	 10°C	 21°C	 15°C	 STOCK (Kg)	 (mm)	 (mm)	 SPIKA 6gr 23 mm (W) x 11 mm (D) x 26 mm (H) DURCHSCHNITTSGRÖßE	 SPIKA 12gr 26 mm (W) x 23 mm (D) x 26 mm (H) DURCHSCHNITTSGRÖßE
SPIKA NG90 L		87	80	35	Breite 660 Tiefe 700 Höhe 832*	Breite 745 Tiefe 770 Höhe 970				
SPIKA NG90 W		87	80							

* MIT FÜßEN 937/987

ZUBEHÖR

EINBEGRIFFEN



EMPFOHLEN



TECHNISCHE DATEN

SPIKA NG90

RECHTE SEITENSICHT

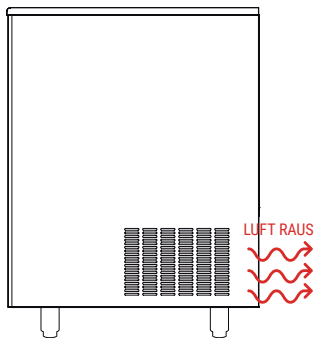

FRONTANSICHT

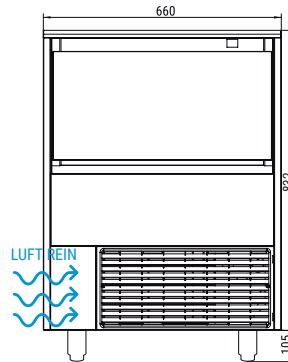

LINKE SEITENSICHT

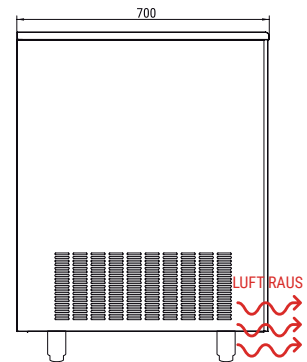

RÜCKANSICHT

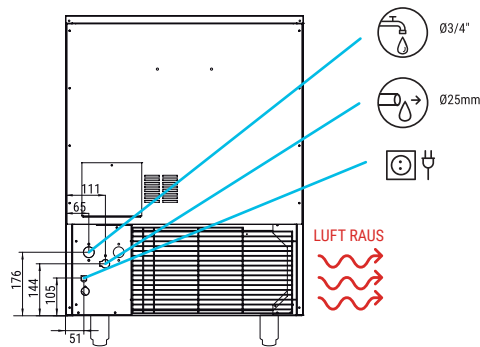

* Alle Größen in mm.

LEISTUNGEN

PRODUKTION 50Hz

±10% V

10°C/43°C

5°C/38°C

1 bar/6 bar

120/240 Eiskegel/Zyklus

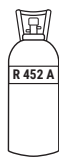

V	Hz	ph
230	50	1N

SPIKA NG90 LUFTGEKÜHLT

°C °F	10° 50°	15° 60°	21° 70°	30° 86°
	10° 50°	95	90	87
21° 68°	90	84	81	77
32° 90°	75	70	66	62
43° 109°	72	59	55	50

SPIKA NG90 WASSERGEKÜHLT

°C °F	10° 50°	15° 60°	21° 70°	30° 86°
	10° 50°	96	90	87
21° 68°	90	85	81	81
32° 90°	75	70	69	68
43° 109°	72	62	61	55

MODELLE

SPIKA NG90 L

SPIKA NG90 W

MODELLE	+c° -c°	ASHRAE KONDITIONEN (W) (BTu/h)	(W) 43°C	(n.) (mm²)	SICHERUNG	100 Kg (Kwh)	FULL HALF (l/h)	WÄRME (W) (BTu/h)	(Kg)	(Kg)	(m³)
SPIKA NG90 L		245 836	550	2 1,5	10	17	11 11	- -	68	81	0,56
SPIKA NG90 W		245 836	580	2 1,5	10	13	45 45	- -	68	81	0,56



ITV ICE MAKERS, S.L.
POL. IND. SECTOR 13, AVDA. DELS HOSTALERS, 2
46394 RIBARROJA DE TURIA, VALENCIA, SPAIN
PHONE: +34 96 166 75 75 | FAX: +34 96 166 81 00
info@itv.es | www.itv.es



SERVICE
service@itv.es
Skype: ITV.Service
+34 961 667 639
8:00AM | 7:00PM



Auf Teile und Lohn.
Vorbehaltlich bestimmter
Einschränkungen und
Auschlüsse.

