

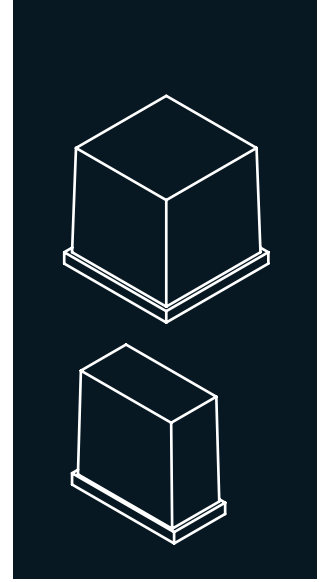









SPIKA NG140 230 V / 50 Hz

SELF-CONTAINED ICE CUBE MACHINE

FEATURES CARATTERISTICHE

- ▶ **PRODUCES FULL DICE ICE CUBES OR HALF DICE ICE CUBES**
PRODUCE CUBETTI A DADO E A MEZZO DADO
- ▶ **STIF: STRONG INOX FRAME. SOLID MACHINE STRUCTURE IN 4 COLUMNS WITH AISI 304 STAINLESS STEEL FRAME**
- ▶ **STIF: STRONG INOX FRAME. MACCHINA CON ASSETTO SOLIDO A 4 COLONNE E STRUTTURA IN ACCIAIO INOSSIDABILE AISI 304**
- ▶ **STRONGEST DOOR IN THE MARKET. MADE OF STAINLESS STEEL. OPENING AND DAMPING SYSTEM PATENTED BY ITV**
- ▶ **LO SPORTELLO PIÙ SOLIDO SUL MERCATO. FABBRICATO IN ACCIAIO INOSSIDABILE. SISTEMA DI APERTURA E SMORZAMENTO BREVETTATO DA ITV**
- ▶ **FRONT VENTILATION CONCEPT: FRONTAL IN-OUT AIR SYSTEM ALLOWS 'BUILT IN' MACHINES**
- ▶ **CONCETTO FRONT VENTILATION: VENTILAZIONE FRONTALE IN-OUT CHE PERMETTE DI INCASSARE LA MACCHINA**
- ▶ **CLEANING SWITCH: ALLOWS CIRCULATION OF WATER WITH DESCALING PRODUCT (CALCLIN OR SIMILAR) WITHOUT COOLING**
- ▶ **PULSANTE DELLA PULIZIA: PERMETTE IL RICIRCOLO DELL'ACQUA CON UN PRODOTTO DISINCROSTANTE (CALCLIN O SIMILE) SENZA REFRIGERAZIONE**
- ▶ **"NEVER STOP" MOTOR PUMP DEVELOPED BY ITV. PUMP WITHOUT SEALS, WHICH AVOIDS DETERIORATION IN HARD WATER**
- ▶ **POMPA "NEVER STOP" IDEATA DA ITV. POMPA SENZA GUARNIZIONI CHE EVITA IL DETERIORAMENTO IN ACQUE DURE**
- ▶ **EASI: EASY ACCESS FOR SERVICE & INSTALLATION. ALL PANELS CAN BE DISASSEMBLED SEPARATELY**
- ▶ **EASY ACCESS FOR SERVICE & INSTALLATION. ACCESSO FACILE A QUALSIASI PUNTO GRAZIE AI PANNELLI ESTRAIBILI SINGOLARMENTE**
- ▶ **ON/OFF LIGHTED ROCKER SWITCH IN FRONT PANEL**
- ▶ **SPIA LUMINOSA DI FUNZIONAMENTO ON/OFF SUL PANNELLO FRONTALE**
- ▶ **TROPICALIZED MACHINES (T CLASS) / HEIGHT ADJUSTABLE LEGS FROM 105MM TO 155MM**
- ▶ **MACCHINE TROPICALIZZATE (CLASSE T) / PIEDINI CON ALTEZZA REGOLABILE DA 105MM A 155MM**



	 24 H	 10°C	 10°C	 21°C	 15°C	 STOCK		
	(Kg)	(Kg)	(Kg)	(Kg)	(Kg)	(mm)	(mm)	
SPIKA NG140 A		155	145		45	Width 761 Depth 762 Height 832*	Width 840 Depth 825 Height 950	
SPIKA NG140 W		-	-					

SPIKA HALF DICE 6gr
23 mm (W) x 11 mm (D) x 26 mm (H)
0,9" (W) x 0,4" (D) x 1" (H)
Average dimensions Dimensioni medie

SPIKA FULL DICE 12gr
26 mm (W) x 23 mm (D) x 26 mm (H)
1" (W) x 0,9" (D) x 1" (H)
Average dimensions Dimensioni medie

* WITH LEGS 937/987 CON PIEDINI 937/987

ACCESSORIES ACCESSORI

INCLUDED



WATER INLET HOSE
TUBO INGRESSO DELL'ACQUA



WATER OUTLET HOSE
TUBO DI SCARICO



4 HEIGHT ADJUSTABLE LEG KIT
KIT 4 PIEDINI ALTEZZA REGOLABILE



WATER INLET FILTER GASKET
GIUNTA DEL FILTRO DI INGRESSO DELL'ACQUA



MEDIUM SCOOP
PALA MEDIA

NOT INCLUDED (OPTIONAL)



ANTI-LIMESCALE FILTER
FILTRO ANTICALCARE



PARTICLE FILTER
FILTRO ANTIPARTICOLATO



ANTI-CHLORINE FILTER
FILTRO ANTICLORO



ANTI-LIMESCALE + ANTI-CHLORINE FILTER CS101
FILTRO ANTICALCARE + ANTICLORO CS101



C4 WATER SOFTENER
DESCALCIFICATORE C4



CALCLIN 50 CLEANER
PRODOTTO ANTICALCARE



4 WHEELS KIT
KIT 4 ROTELLE

SPIKA NG140

TOP VIEW
VISTA SUPERIORE

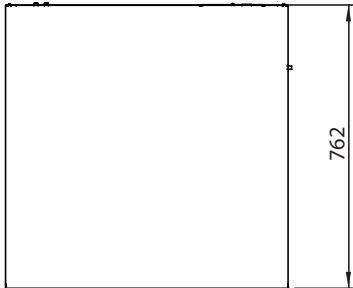

FRONTAL VIEW
VISTA FRONTALE

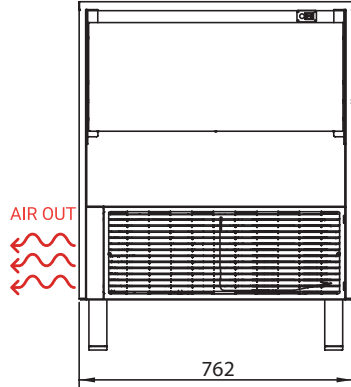

REAR VIEW
VISTA POSTERIORE

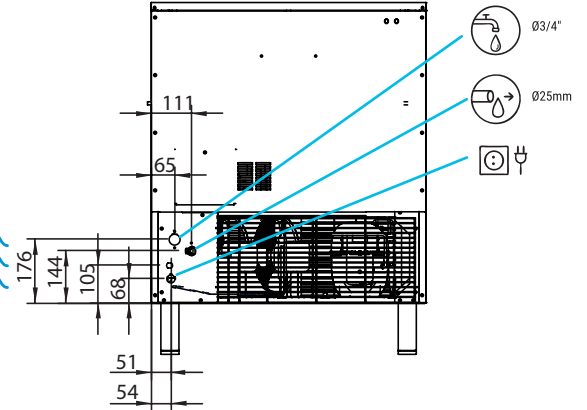

* All measurements in mm.
* Tutte le misure in mm.

OPERATING CONDITIONS CONDIZIONI PER IL FUNZIONAMENTO

PRODUCTION 50Hz PRODUZIONE 50 Hz

±10% V

10°C/43°C

5°C/38°C

1 bar/6 bar

144/288 Ice cubes/cycle

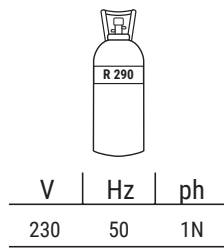

SPIKA NG140 AIR COOLED

°C / °F	10° / 50°	15° / 60°	21° / 70°	30° / 86°
10° / 50°	155	150	136	121
21° / 68°	148	145	130	115
32° / 90°	125	120	107	92
43° / 109°	105	100	90	75

SPIKA NG140 WATER COOLED

°C / °F	10° / 50°	15° / 60°	21° / 70°	30° / 86°
10° / 50°	-	-	-	-
21° / 68°	-	-	-	-
32° / 90°	-	-	-	-
43° / 109°	-	-	-	-

MODELS
MODELLI

	ASHRAE CONDITIONS CONDIZIONI ASHRAE	(W)	(BTU/h)	(W) 43°C	(n.)	(mm ²)	FUSE	100 Kg (Kwh)	(l/h) FULL HALF	HEAT REJECTED (W) (BTU/h)	(Kg)	(Kg)	(m ³)
SPIKA NG140 A		1.868	6.374	700	3	1,5	16	9,6	14,4 14,4	1.363 1.363	81	87	0,68
SPIKA NG140 W		1.868	6.374	700	3	1,5	16	-	- -	- -	81	87	0,68



ITV ICE MAKERS, S.L.
POL. IND. SECTOR 13, AVDA. DELS HOSTALERS, 2
46394 RIBARROJA DE TURIA, VALENCIA, SPAIN
PHONE: +34 96 166 75 75 | FAX: +34 96 166 81 00
info@itv.es | www.itv.es



SERVICE
SERVIZIO ASSISTENZA TECNICA
service@itv.es
Skype: ITV.Service
+34 961 667 639
8:00AM | 7:00PM



Subject to certain limitations
and exclusions. Only spare parts.
Soggetta a limitazioni e revoca. Solo
parti di ricambio.

