

SPIKA NG100









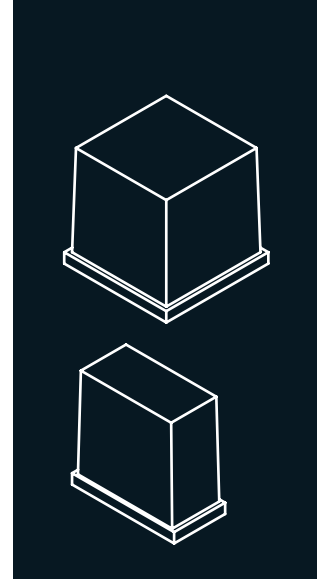

230 V / 50 Hz

MACHINE À GLAÇONS INDÉPENDANTE

FEATURES CARACTÉRISTIQUES

- ▶ **PRODUCES FULL DICE ICE CUBES OR HALF DICE ICE CUBES.**
PRODUCTION DE DÉS OU DE DEMI-DÉ.
- ▶ **STIF: STRONG INOX FRAME. SOLID MACHINE STRUCTURE IN 4 COLUMNS WITH AISI 304 STAINLESS STEEL FRAME.**
STIF: STRONG INOX FRAME. MACHINE AVEC STRUCTURE SOLIDE DE 4 COLONNES ET CARROSSERIE EN ACIER INOXYDABLE AISI 304.
- ▶ **CLEANING SWITCH: ALLOWS CIRCULATION OF WATER WITH DESCALING PRODUCT (CALKLIN OR SIMILAR) WITHOUT COOLING.**
BOUTON DE NETTOYAGE : PERMET DE FAIRE RECIRCULER L'EAU AVEC LE DÉSINCRUSTANT (CALKLIN OU ÉQUIVALENT) SANS RÉFRIGÉRATION.
- ▶ **EASI: EASY ACCESS FOR SERVICE & INSTALLATION. ALL PANELS CAN BE DISASSEMBLED SEPARATELY.**
EASI : EASY ACCESS FOR SERVICE & INSTALLATION. ACCÈS FACILE À TOUS LES POINTS CAR TOUS LES PANNEAUX PEUVENT ÊTRE DÉMONTÉS INDÉPENDAMMENT.
- ▶ **STRONGEST DOOR OPENING SYSTEM PATENTED BY ITV. DOOR MADE IN STAINLESS STEEL AISI 304.**
LA PORTE LA PLUS SOLIDE DU MARCHÉ. FABRIQUÉ EN ACIER INOXYDABLE. SYSTÈME D'OUVREMENT ET AMORTISSEURS BREVETÉS PAR ITV.
- ▶ **SMART FRONT VENTILATION SYSTEM (SFVS) ALLOWS BUILT-IN INSTALLATION OF THE UNIT.**
LE SYSTÈME INTELLIGENT DE VENTILATION FRONTALE (SFVS) PERMET D'INSTALLER LA MACHINE DE MANIÈRE ENCASTRÉE.
- ▶ **ELECTRONIC CONTROL THAT ENHANCES THE PERFORMANCE OF THE MACHINE AND ALLOWS IT TO ADAPT TO EXTREME CLIMATES.**
CONTRÔLE ÉLECTRONIQUE QUI AMÉLIORE LES PERFORMANCES DE LA MACHINE ET LUI PERMET DE S'ADAPTER AUX CLIMATS EXTRÊMES.
- ▶ **NATURAL GAS R290 WITH VERY LOW GLOBAL WARMING POTENTIAL WHICH ALSO REDUCES THE ENERGY CONSUMPTION**
GAZ NATUREL R290 AVEC UN INDICE GWP TRÈS BAS QUI RÉDUIT ÉGALEMENT LA CONSOMMATION D'ÉNERGIE.
- ▶ **LED ON/OFF SWITCH / PCB MOUNTED AT THE BOTTOM**
INTERRUPTEUR LUMINEUX DE FONCTIONNEMENT ON/OFF / PLAQUE ÉLECTRONIQUE MONTÉE DANS LA PARTIE INFÉRIEURE.
- ▶ **TROPICALIZED MACHINES (T CLASS) / HEIGHT ADJUSTABLE LEGS FROM 105MM TO 155MM**
MACHINES TROPICALISÉES (CLASSE T) / PIEDS RÉGLABLES EN HAUTEUR DE 105 MM À 155 MM.



	 24 H	 10°C (Kg)	 10°C (Kg)	 21°C (Kg)	 15°C (Kg)	 STOCK (Kg)	 (mm)	 (mm)
SPIKA NG100 A		100	99			35	Width 660 Depth 700 Height 832*	Width 740 Depth 720 Height 955
SPIKA NG100 W		-	-					

SPIKA HALF DICE 6gr
23 mm (W) x 11 mm (D) x 26 mm (H)
Average dimensions Dimensions moyennes

SPIKA FULL DICE 12gr
26 mm (W) x 23 mm (D) x 26 mm (H)
Average dimensions Dimensions moyennes

* WITH LEGS 937/987 AVEC PIEDS 937/987

ACCESSORIES ACCESSOIRES

INCLUDED



WATER INLET HOSE
TUYAU D'ENTRÉE D'EAU



WATER OUTLET HOSE
JOINT DE FILTRE D'ENTRÉE D'EAU



4 HEIGHT ADJUSTABLE LEG KIT
KIT 4 ROUES RÉGLABLES EN HAUTEUR



WATER INLET FILTER GASKET
JOINT DE FILTRE D'ENTRÉE D'EAU



MEDIUM SCOOP
PALE MOYENNE

NOT INCLUDED (OPTIONAL)



ANTI-LIMESCALE FILTER
FILTRE ANTICALCAIRE



PARTICLE FILTER
FILTRE ANTIPARTICULES



ANTI-CHLORINE FILTER
FILTRE ANTI-CHLORE



ANTI-LIMESCALE + ANTI-CHLORINE FILTER CS101
FILTRE ANTICALCAIRE + ANTI-CHLORE CS101



C4 WATER SOFTENER
ADOUCCISSEUR C4



CALKLIN 50 CLEANER
PRODUIT ANTICALCAIRE



4 WHEELS KIT
KIT 4 ROUES

SPIKA NG100

SIDE VIEW
VUE LATÉRALE

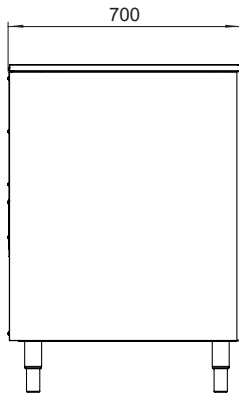

FRONTAL VIEW
VUE DE FACE

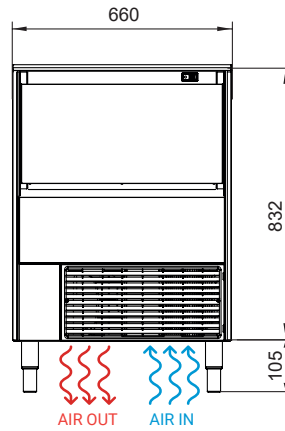

REAR VIEW
VUE ARRIÈRE

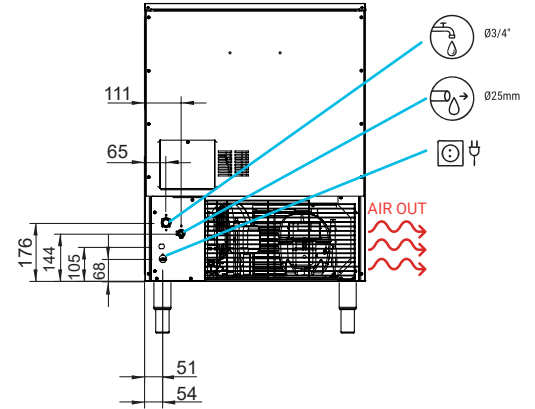

*All measurements in mm.
*Toutes les cotes sont en mm.

OPERATING CONDITIONS CONDITIONS DE FONCTIONNEMENT

PRODUCTION 50Hz PRODUCTION 50 Hz

±10% V

10°C/43°C

5°C/38°C

1 bar/6 bar

120/240 Ice cubes/cycle

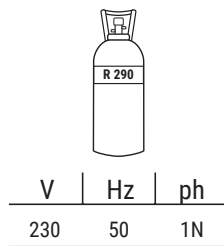

SPIKA NG100 AIR COOLED

°C / °F	10° / 50°	15° / 60°	21° / 70°	30° / 86°
10° / 50°	100	100	80	75
21° / 68°	103	99	75	72
32° / 90°	94	91	73	70
43° / 109°	85	80	58	55

SPIKA NG100 WATER COOLED

°C / °F	10° / 50°	15° / 60°	21° / 70°	30° / 86°
10° / 50°	-	-	-	-
21° / 68°	-	-	-	-
32° / 90°	-	-	-	-
43° / 109°	-	-	-	-

MODÈLES

SPIKA NG100 A

SPIKA NG100 W

	ASHRAE CONDITIONS CONDITIONS ASHRAE	(W)	(BTu/h)	(W) 43°C	(n.)	(mm ²)	FUSE	100 Kg (Kwh)	(l/h)	HEAT REJECTED (W) (BTu/h)	(Kg)	(Kg)	(m ³)
SPIKA NG100 A		1.224	4.174	465	3	1,5	16	9,7 10,1	9,8 9,4	862 2.939	64	76	0,51
SPIKA NG100 W		-	-	-	-	-	-	-	-	-	-	-	-



ITV ICE MAKERS, S.L.
POL. IND. SECTOR 13, AVDA. DELS HOSTALERS, 2
46394 RIBARROJA DE TURIA, VALENCIA, SPAIN
PHONE: +34 96 166 75 75 | FAX: +34 96 166 81 00
info@itv.es | www.itv.es



SERVICE SERVICE D'ASSISTANCE TECHNIQUE
service@itv.es
Skype: ITV.Service
+34 961 667 639
8:00AM | 7:00PM



Subject to certain limitations and exclusions. Only spare parts.
Sujet à limitations et exclusions. Pièces de rechange uniquement.

