

SPIKA MS410





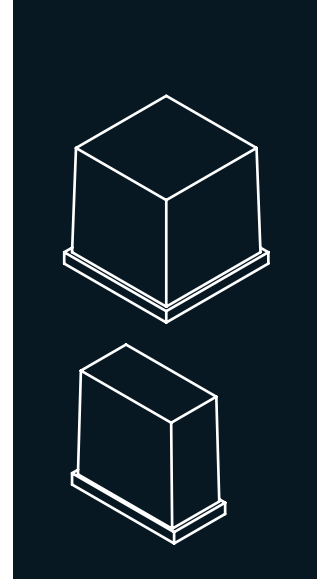

THREE PHASE
400 V / 50 Hz

MODULAR ICE CUBE MACHINE

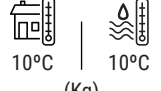
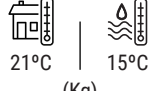
FEATURES CARATTERISTICHE

- ▶ **PRODUCES FULL DICE ICE CUBES OR HALF DICE ICE CUBES**
PRODUCE CUBETTI A DADO E A MEZZO DADO
- ▶ **HIGH EFFICIENT EVAPORATOR**
EVAPORATORE AD ALTA EFFICIENZA
- ▶ **SMART WATER DISTRIBUTOR THAT IMPROVES DROP-OFF EFFICIENCY**
DISTRIBUTORE INTELLIGENTE DI ACQUA CHE MIGLIORA L'EFFICIENZA DURANTE LA RIMOZIONE
- ▶ **EASY ACCESS BY REMOVING THE PANELS WITH A SINGLE SCREWDRIVER**
ACCESSO FACILE MEDIANTE LA RIMOZIONE DEI PANNELLI CON UN SOLO CACCIAVITE
- ▶ **SMART ELECTRONIC BOARD CONTROLS EVERY PARAMETER IN THE MACHINE AND SHOWS THE DIAGNOSIS OF POSSIBLE INCIDENCES**
PLACCA ELETTRONICA INTELLIGENTE CHE CONTROLLA I PARAMETRI DELLA MACCHINA E INDICA LA DIAGNOSI DI EVENTUALI PROBLEMI
- ▶ **ENERGY STAR, LOW POWER CONSUMPTION CERTIFICATION**
ENERGY STAR, CERTIFICATO DI BASSO CONSUMO ELETTRICO
- ▶ **HIGH RESISTANCE EXTERNAL FRAME IN AISI 304 STAINLESS STEEL**
STRUTTURA AD ALTA RESISTENZA IN ACCIAIO INOSSIDABILE AISI 304



						
	24 H	10°C 10°C	21°C 15°C	(mm)	(mm)	SPIKA HALF DICE 6gr 23 mm (W) x 11 mm (D) x 26 mm (H) 0.9" (W) x 0.4" (D) x 1" (H) Average dimensions Dimensioni medie
SPIKA MS410 A		424	405	Width 760 Depth 620 Height 762	Width 836 Depth 635 Height 874	
SPIKA MS410 W		436	416			SPIKA FULL DICE 12gr 26 mm (W) x 23 mm (D) x 26 mm (H) 1" (W) x 0.9" (D) x 1" (H) Average dimensions Dimensioni medie

ACCESSORIES ACCESSORI

INCLUDED



WATER INLET FILTER GASKET
GIUNTURA DEL FILTRO DI INGRESSO DELL'ACQUA



WATER INLET HOSE
TUBO INGRESSO DELL'ACQUA



WATER OUTLET HOSE
TUBO DI SCARICO

NOT INCLUDED (OPTIONAL)



ANTI-LIMESCALE FILTER
FILTRO ANTICALCARE



PARTICLE FILTER
FILTRO ANTIPARTICOLATO



ANTI-LIMESCALE + ANTI-CHLORINE FILTER CS101
FILTRO ANTICALCARE + ANTICLORO CS101

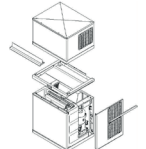

STACKING KIT
KIT IMPILAMENTO

RECOMMENDED BINS SERBATOIO RACCOMANDATI

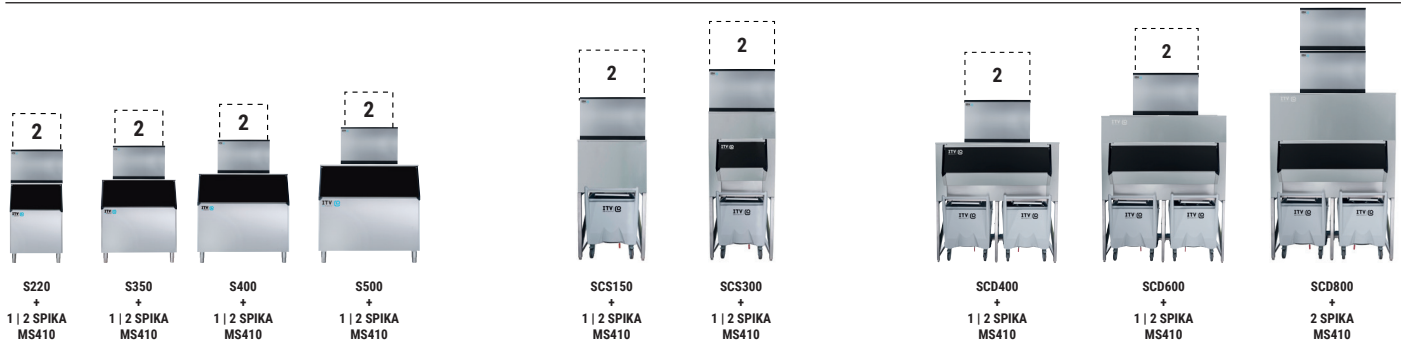

SPIKA MS410

RIGHT SIDE VIEW
VISTA LATERALE DESTRA

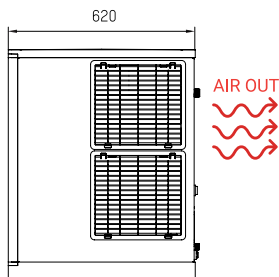

FRONTAL VIEW
VISTA FRONTALE

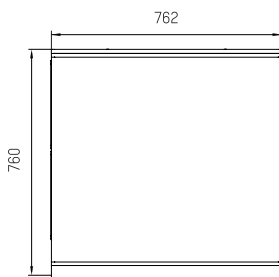

REAR VIEW
VISTA POSTERIORE

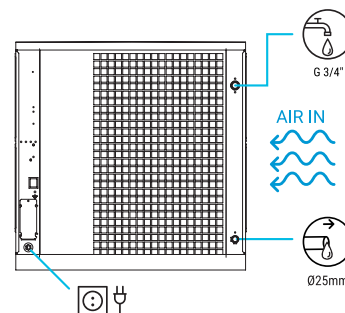

CENTRAL CROSS SECTION VIEW OF THE BASE
VISTA DELLA BASE DALLA ZONA CENTRALE

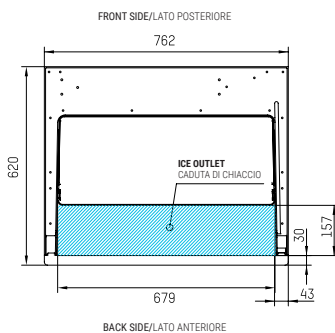

* All measurements in mm.
* Tutte le misure in mm.

OPERATING CONDITIONS CONDIZIONI PER IL FUNZIONAMENTO

PRODUCTION 50Hz PRODUZIONE 50 Hz

±10% V

10°C/43°C

5°C/38°C

1 bar/6 bar

400/800 Ice cubes/cycle

V	Hz	ph
400	50	3N

SPIKA MS410 AIR COOLED

°C °F	10° 50°	15° 60°	21° 70°	30° 86°
	10° 50°	424	412	395
21° 68°	413	405	386	368
32° 90°	359	333	301	284
43° 109°	293	259	232	217

SPIKA MS410 WATER COOLED

°C °F	10° 50°	15° 60°	21° 70°	30° 86°
	10° 50°	436	423	406
21° 68°	425	416	397	378
32° 90°	369	342	310	291
43° 109°	301	266	239	223

MODELS
MODELLI

SPIKA MS410 A

SPIKA MS410 W

	ASHRAE CONDITIONS CONDIZIONI ASHRAE	(W) (BTU/h)	(W) 43°C	(n.) (mm ²)	FUSE	100 Kg (Kwh)	FULL HALF (l/h)	HEAT REJECTED (W) (BTU/h)	(Kg)	(Kg)	(m ³)
SPIKA MS410 A		11.185 38.185	1.540	3 2,5	15	9,9	17 17	3.505 11.960	105	110	0,53
SPIKA MS410 W		11.185 38.185	1.540	3 2,5	10	9,9	110 110	3.505 11.960	105	110	0,53



ITV ICE MAKERS, S.L.
POL. IND. SECTOR 13, AVDA. DELS HOSTALERS, 2
46394 RIBARROJA DE TURIA, VALENCIA, SPAIN
PHONE: +34 96 166 75 75 | FAX: +34 96 166 81 00
info@itv.es | www.itv.es



SERVICE
SERVIZIO ASSISTENZA TECNICA
service@itv.es
Skype: ITV.Service
+34 961 667 639
8:00AM | 7:00PM



Subject to certain limitations
and exclusions. Only spare parts.
Soggetta a limitazioni e revoca. Solo
parti di ricambio.

