









SCALA 5000 THREE PHASE 400 V / 50 Hz

MODULAR FLAKE ICE MACHINE

FEATURES CARATTERISTICHE

- PRODUCES COLD AND DRY FLAT FLAKES. FLAKE THICKNESS MAY BE ADJUSTED BETWEEN 1.5 mm AND 3 mm**
▶ PRODUCE SCAGLIE PIANE MOLTO FREDDI E ASCIUTTE. LO SPESSORE È REGOLABILE DA 1.5 A 3 mm
- BASED ON A STATIC CYLINDER WHICH IS FREE FROM SWIVEL JOINTS (HELICAL REAMER) COUPLED WITH A MILLING TOOL THAT DETACHES THE ICE WITHOUT ANY STRAINED OR FORCED MOVEMENTS**
▶ FUNZIONAMENTO BASATO SU UN CILINDRO STATICO SENZA GIUNTI ROTANTI (ALESATORE ELICOIDALE) E CON UNA FRESA CHE STACCA IL GHIACCIO SENZA TENSIONE O SFORZO
- THE MOST EFFICIENT EVAPORATOR OF THE MARKET, LESS ENERGY CONSUMPTION AND HIGHER ICE PRODUCTION**
▶ L'EVAPORATORE PIÙ EFFICIENTE SUL MERCATO, CONSUMO ENERGETICO MINORE, MAGGIORE PRODUZIONE DI GHIACCIO
- ELECTRONIC STOP SYSTEM / ELECTRICAL CONTROL PANEL / DRIVE DIRECT GEAR MOTOR / MAGNETIC DRIVE PUMP / LOW WATER SAFETY DEVICE**
▶ SISTEMA ELETTRONICO DI ARRESTO / PANNELLO DI CONTROLLO ELETTRICO / MOTORIDUTTORE CON TRASMISSIONE DIRETTA / POMPA A TRASCINAMENTO MAGNETICO / DISPOSITIVO DI SICUREZZA IN CASO DI MANCANZA DI ACQUA
- STAINLESS STEEL SOLEPLATE**
▶ PIASTRA IN ACCIAIO INOSSIDABILE
- CONTROLLERS TO DETECT: LOW WATER LEVEL, TEMPERATURE RISE DUE TO MOTOR OVERLOAD OR FULL VAT**
▶ DISPOSITIVI PER RILEVARE: MANCANZA DI ACQUA, AUMENTO DELLA TEMPERATURA A CAUSA DEL SOVRACCARICO DEL MOTORE O PER RIEMPIMENTO DELLA VASCHETTA



	 24 H	 10°C	 10°C	 21°C	 15°C			
	(Kg)	(Kg)	(Kg)	(Kg)	(Kg)	(mm)	(mm)	
SCALA 5000		5.500	5.000	Width 3.900 Depth 1.220 Height 1.550	Width 4.300 Depth 1.500 Height 1.800	FLAKE ICE -7°C Ice Temperature		

ACCESSORIES ACCESSORI

OPTIONAL (NON INCLUSO)



SALT DOSING PUMP WITH TANK
BOMBA DOSATORE DI SALE CON DEPOSITO



REMOTE SWITCH
INTERRUTTORE REMOTO



REMOTE SWITCH & WEEKLY PROGRAMMER
INTERRUTTORE REMOTO CON TIMER SETTIMANALE



EXTERNAL STOP FULL BIN PHOTO CELL
SENSORE DI ARRESTO ESTERNO PER RIEMPIMENTO

RECOMMENDED BINS SERBATOIO RACCOMANDATI



SS422 + SCALA 5000



SS623 + SCALA 5000



SS732 + SCALA 5000

SCALA 5000

RIGHT SIDE VIEW
VISTA LATERALE DESTRA

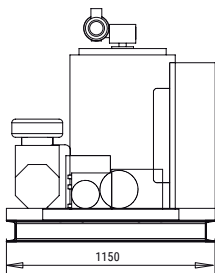

FRONTAL VIEW
VISTA FRONTALE

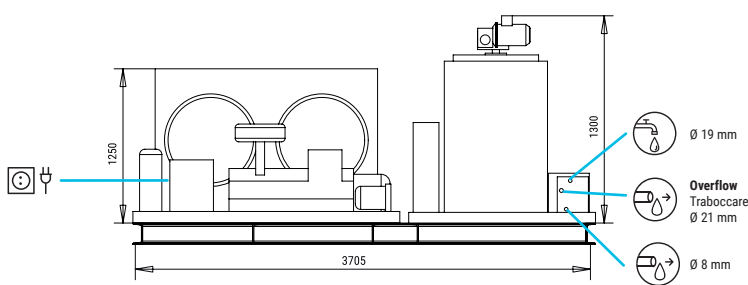

LEFT SIDE VIEW
VISTA LATERALE SINISTRA

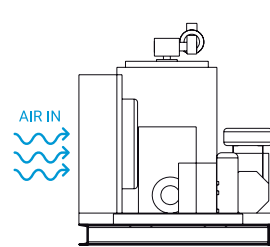

CENTRAL CROSS SECTION
VIEW OF THE BASE
VISTA DELLA BASE DALLA ZONA CENTRALE

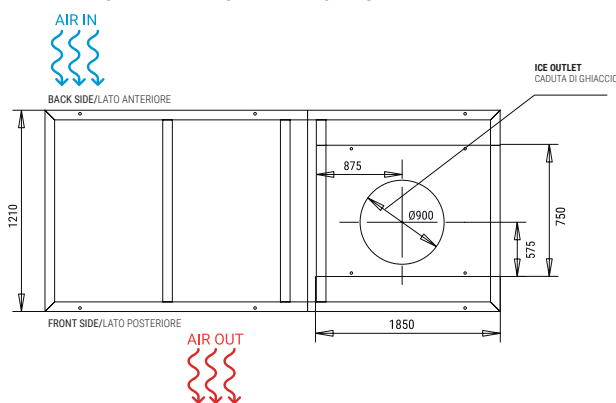

* All measurements in mm.
* Tutte le misure in mm.

OPERATING CONDITIONS CONDIZIONI PER IL FUNZIONAMENTO

PRODUCTION 50Hz PRODUZIONE 50 Hz

±10% V

10°C/43°C

5°C/38°C

1 bar/6 bar

V	Hz	ph
400	50	3N

°C / °F	SCALA 5000			
	10° / 50°	15° / 60°	21° / 70°	30° / 86°
10° / 50°	5500	5200	4500	4200
21° / 68°	5450	5000	4300	3900
32° / 90°	5100	4700	4000	3600
43° / 109°	4400	3900	3250	3000

MODELS / MODELLI	Temp.EV. (°C)	ASHRAE CONDITIONS (W) (BTU/h)	(W) 43°C	(n.) (mm²)	FUSE	100 Kg (Kw/h)	(l/h)	HEAT REJECTED (W) (BTU/h)	(Kg)	(Kg)	(m³)
SCALA 5000	-22	27.500 93.834	23.475	5 10	40	9,3	208,3	33.000 112.601	1.450	1.806	11,6



ITV ICE MAKERS, S.L.
POL. IND. SECTOR 13, AVDA. DELS HOSTALERS, 2
46394 RIBARROJA DE TURIA, VALENCIA, SPAIN
PHONE: +34 96 166 75 75 | FAX: +34 96 166 81 00
info@itv.es | www.itv.es



SERVICE SERVIZIO ASSISTENZA TECNICA
service@itv.es
Skype: ITV.Service
+34 961 667 639
8:00AM | 7:00PM



Subject to certain limitations and exclusions. Only spare parts.
Soggetta a limitazioni e revoca. Solo parti di ricambio.

