









## SCALA 5000 DREIPHASIG 400 V / 50 Hz

### MODULARER SCHERBENEISBEREITER

#### EIGENSCHAFTEN

- ▶ PRODUZIERT SEHR KALTE UND TROCKENE SCHERBEN. DIE DICKE KANN ZWISCHEN 1,5 UND 3 MM REGULIERT WERDEN
- ▶ BETRIEB BASIERT AUF EINEM STATISCHEN ZYLINDER OHNE DREHGELENKE (HELICAL REAMER) ZUSAMMEN MIT EINEM FRÄSWERKZEUG, DAS DAS EIS OHNE BELASTUNG ODER ANSTRENGUNG ZERBRICHT
- ▶ DER EFFIZIENTESTE VERDAMPFER DES MARKTES, WENIGER ENERGIEVERBRAUCH UND HÖHERE EISPRODUKTION
- ▶ ELEKTRONISCHES STOP-SYSTEM / ELEKTRISCHE STEUERUNG / GETRIEBEMOTOR MIT DIREKTEM ANGRIFF/ MAGNETISCHE ANTRIEBSPUMPE / NIEDRIGE WASSERSICHERHEITSVORRICHTUNG
- ▶ EDELSTAHL-SOLEPLATE
- ▶ KONTROLLEN FÜR: WASSERMANGEL, TEMPERATURERHÖHUNG DURCH ÜBERBELASTUNG DES GETRIEBEMOTORS ODER BEHÄLTERBEFÜLLUNG



	 24 H	 10°C	 10°C	 21°C	 15°C			
		(Kg)	(Kg)	(Kg)	(Kg)	(mm)	(mm)	
SCALA 5000		5.500	5.000	Breite 3.900 Tiefe 1.220 Höhe 1.550	Breite 4.300 Tiefe 1.500 Höhe 1.800	<b>SCHERBENEIS</b> -7°C Eistemperatur		

#### ZUBEHÖR

##### EMPFOHLEN



SALZDOSIERPUMPE  
MIT TANK



SCHALTER  
FERNBEDIENUNG



KIPPSCHALTER  
FERNBEDIENUNG &  
WOCHENPROGRAMMIERUNG



EXTERNER  
KIPPSCHALTER MIT  
PHOTOZELLENSTOPP  
FÜR BEHÄLTER

#### EMPFOHLENE VORRATSBEHÄLTER



SS422 + SCALA 5000



SS623 + SCALA 5000



SS732 + SCALA 5000

SCALA 5000

RECHTE SEITENANSICHT

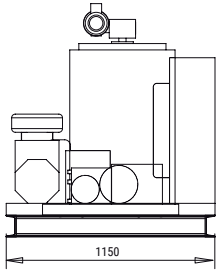

FRONTANSICHT

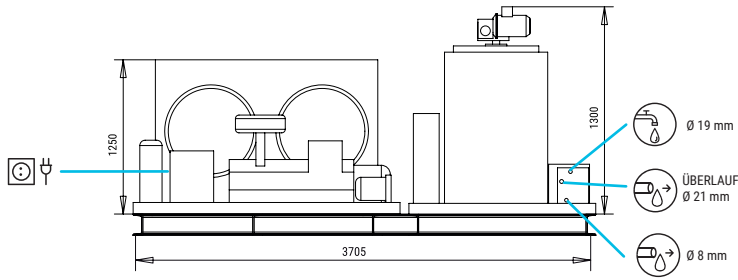

LINKE SEITENANSICHT

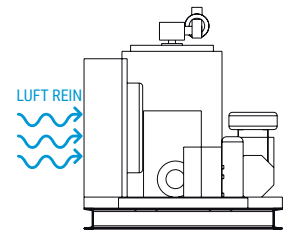

QUERSCHNITT-ANSICHT DER BASIS

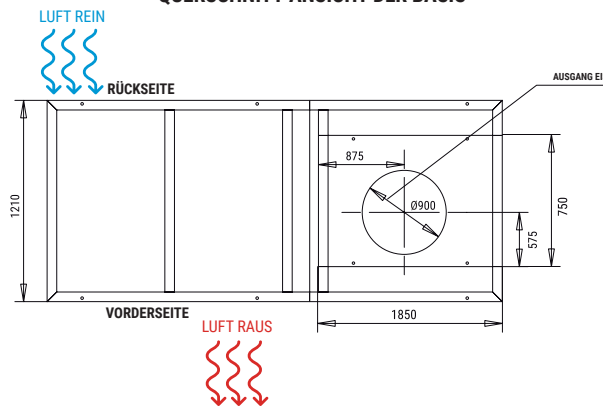

\* Alle Größen in mm.

LEISTUNGEN

PRODUKTION 50Hz

±10% V

10°C/43°C

5°C/38°C

1 bar/6 bar

V	Hz	ph
400	50	3N

24 H L

°C	10°	15°	21°	30°
°F	50°	60°	70°	86°
10°	5500	5200	4500	4200
21°	5450	5000	4300	3900
32°	5100	4700	4000	3600
43°	4400	3900	3250	3000
109°				

24 H L

°C	10°	15°	21°	30°
°F	50°	60°	70°	86°
10°	5115	4836	4185	3906
21°	5069	4650	3999	3627
32°	4743	4371	3720	3348
43°	4092	3627	3023	2790
109°				

MODELLE

SCALA 5000

Temp.EV (°C)	ASHRAE KONDITIONEN (W) (BTU/h)	(W) 43°C	(n.) (mm <sup>2</sup> )	FUSE	(Kw/h)	(l/h)	(W) (BTU/h)	(Kg)	(Kg) (m <sup>3</sup> )
-22	27.500 93.834	23.475	5 10	40	9,3	208,3	33.000 112.601	1.450 1.806	11,6



ITV ICE MAKERS, S.L.  
POL. IND. SECTOR 13, AVDA. DELS HOSTALERS, 2  
46394 RIBARROJA DE TURIA, VALENCIA, SPAIN  
PHONE: +34 96 166 75 75 | FAX: +34 96 166 81 00  
info@itv.es | www.itv.es



SERVICE  
service@itv.es  
Skype: ITV.Service  
+34 961 667 639  
8:00AM | 7:00PM



Auf Teile und Lohn.  
Vorbehaltlich bestimmter  
Einschränkungen und  
Auschlüsse.

