

SCALA 400 REMOTE

MODULARER SCHERBENEISBEREITER

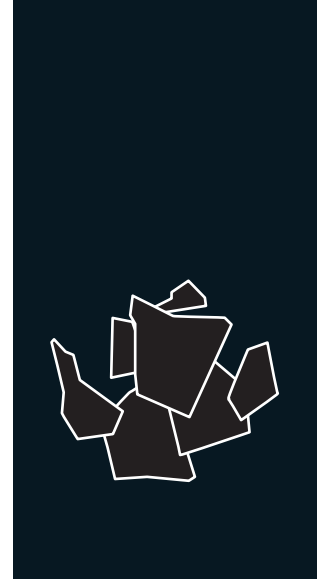





DREI PHASEN
400 V / 50 Hz



EIGENSCHAFTEN

- ▶ PRODUZIERT SEHR KALTE UND TROCKENE SCHERBEN. DIE DICKE KANN ZWISCHEN 1,5 UND 3 MM REGULIERT WERDEN
- ▶ BETRIEB BASIERT AUF EINEM STATISCHEN ZYLINDER OHNE DREHGELLENKE (HELICAL REAMER) ZUSAMMEN MIT EINEM FRÄSWERKZEUG, DAS DAS EIS OHNE BELASTUNG ODER ANSTRENGUNG ZERBRICHT
- ▶ DER EFFIZIENTESTE VERDAMPFER DES MARKTES, WENIGER ENERGIEVERBRAUCH UND HÖHERE EISPRODUKTION
- ▶ ELEKTRONISCHES STOP-SYSTEM / ELEKTRISCHE STEUERUNG / GETRIEBEMOTOR MIT DIREKTEM ANGRIFF / MAGNETISCHE ANTRIEBSPUMPE / NIEDRIGE WASSERSICHERHEITSVORRICHTUNG
- ▶ EDELSTAHL-SOLEPLATE
- ▶ KONTROLLEN FÜR: WASSERMANGEL, TEMPERATURERHÖHUNG DURCH ÜBERBELASTUNG DES GETRIEBEMOTORS ODER BEHÄLTERBEFÜLLUNG



					 SCHERBENEIS -7°C Eistemperatur
	(Kg)	(Kg)	(mm)	(mm)	
SCALA 400 SPLIT 	450	400	Breite 1.090 Tiefe 700 Höhe 760	Breite 1.220 Tiefe 820 Höhe 915	
RCU 400	-	-	Breite 1.108 Tiefe 574 Höhe 690	Breite 1.220 Tiefe 600 Höhe 800	

ZUBEHÖR

EINBEGRIFFEN



EMPFOHLEN



EMPFOHLENE VORRATSBEHÄLTER



TECHNISCHE DATEN



SCALA 400 SPLIT

RECHTE SEITENSICHT

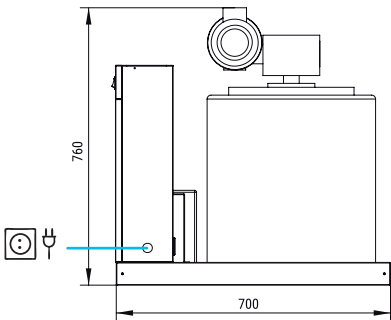

FRONTANSICHT

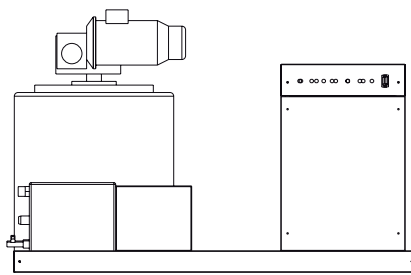

LINKE SEITENSICHT

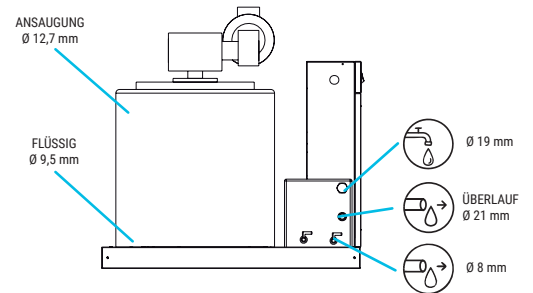

RCU 400

QUERSCHNITT-ANSICHT DER BASIS

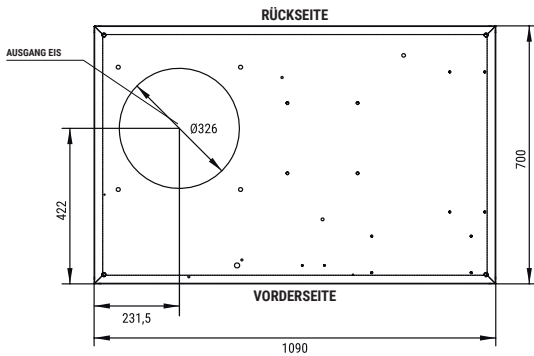

RECHTE SEITENSICHT

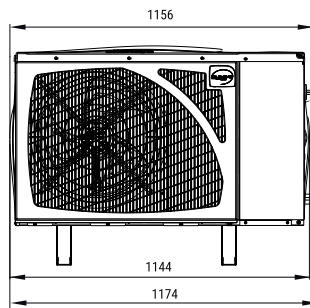

RECHTE SEITENSICHT

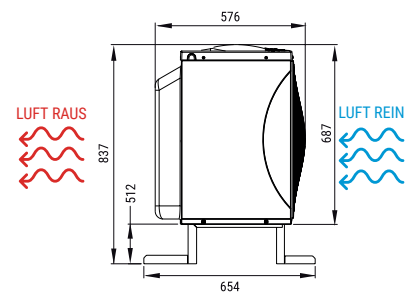

* Alle Größen in mm.

LEISTUNGEN

PRODUKTION 50Hz

±10% V

10°C/43°C

5°C/38°C

1 bar/6 bar

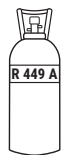

V	Hz	ph
400	50	3N



SCALA 400 REMOTE

°C	10°	15°	21°	30°
°F	50°	60°	70°	86°
10°	450	420	350	310
50°	440	400	335	290
21°	410	360	300	260
68°	335	290	230	200
32°				
90°				
43°				
109°				



SCALA 400 REMOTE

°C	10°	15°	21°	30°
°F	50°	60°	70°	86°
10°	419	391	326	288
50°	409	372	312	270
21°	381	335	279	242
68°	312	270	214	186
32°				
90°				
43°				
109°				

MODELLE

SCALA 400 S

RCU 400

Temp.EV. (°C)	ASHRAE KONDITIONEN (W) (BTU/h)	(W) 43°C	(n.) (mm ²)	FUSE	100 Kg (Kw/h)	(l/h)	(W) (BTU/h)	(Kg)	(Kg)	(m ³)
-22	2.200 7.507	190	3 1,5	16	7,5	16,6	- -	100	127	0,92
-	- 7.507	1.235	5 2,5	16	-	-	2.640 9.008	84	104	0,57



ITV ICE MAKERS, S.L.
POL. IND. SECTOR 13, AVDA. DELS HOSTALERS, 2
46394 RIBARROJA DE TURIA, VALENCIA, SPAIN
PHONE: +34 96 166 75 75 | FAX: +34 96 166 81 00
info@itv.es | www.itv.es



SERVICE
service@itv.es
Skype: ITV.Service
+34 961 667 639
8:00AM | 7:00PM



Auf Teile und Lohn.
Vorbehaltlich bestimmter
Einschränkungen und
Auschlüsse.

