

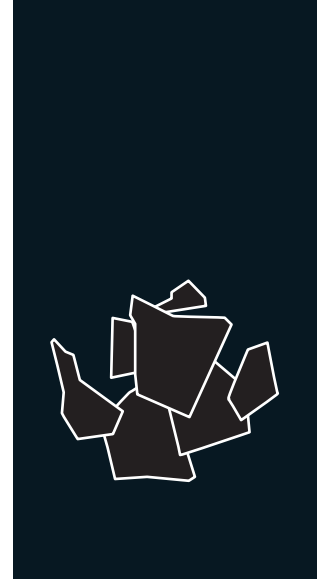





## SCALA 3000 REMOTE THREE PHASE 400 V / 50 Hz

MODULAR FLAKE ICE MACHINE WITH REMOTE UNIT

### FEATURES CARATTERISTICHE

- ▶ **PRODUCES COLD AND DRY FLAT FLAKES. FLAKE THICKNESS MAY BE ADJUSTED BETWEEN 1.5 mm AND 3 mm**  
PRODUCE SCAGLIE PIANE MOLTO FREDDI E ASCIUTTE. LO SPESSORE È REGOLABILE DA 1.5 A 3 mm
- ▶ **BASED ON A STATIC CYLINDER WHICH IS FREE FROM SWIVEL JOINTS (HELICAL REAMER) COUPLED WITH A MILLING TOOL THAT DETACHES THE ICE WITHOUT ANY STRAINED OR FORCED MOVEMENTS**  
FUNZIONAMENTO BASATO SU UN CILINDRO STATICO SENZA GIUNTI ROTANTI (ALESATORE ELICOIDALE) E CON UNA FRESA CHE STACCA IL GHIACCIO SENZA TENSIONE O SFORZO
- ▶ **THE MOST EFFICIENT EVAPORATOR OF THE MARKET, LESS ENERGY CONSUMPTION AND HIGHER ICE PRODUCTION**  
L'EVAPORATORE PIÙ EFFICIENTE SUL MERCATO, CONSUMO ENERGETICO MINORE, MAGGIORE PRODUZIONE DI GHIACCIO
- ▶ **ELECTRONIC STOP SYSTEM / ELECTRICAL CONTROL PANEL / DRIVE DIRECT GEAR MOTOR / MAGNETIC DRIVE PUMP / LOW WATER SAFETY DEVICE**  
SISTEMA ELETTRONICO DI ARRESTO / PANNELLO DI CONTROLLO ELETTRICO / MOTORIDUTTORE CON TRASMISSIONE DIRETTA / POMPA A TRASCINAMENTO MAGNETICO / DISPOSITIVO DI SICUREZZA IN CASO DI MANCANZA DI ACQUA
- ▶ **STAINLESS STEEL SOLEPLATE**  
PIASTRA IN ACCIAIO INOSSIDABILE
- ▶ **CONTROLLERS TO DETECT: LOW WATER LEVEL, TEMPERATURE RISE DUE TO MOTOR OVERLOAD OR FULL VAT**  
DISPOSITIVI PER RILEVARE: MANCANZA DI ACQUA, AUMENTO DELLA TEMPERATURA A CAUSA DEL SOVRACCARICO DEL MOTORE O PER RIEMPIMENTO DELLA VASCHETTA

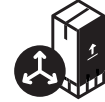

	 24 H	 10°C (Kg)	 15°C (Kg)	 (mm)	 (mm)	 <b>FLAKE ICE</b> -7°C Ice Temperature
SCALA 3000 SPLIT		3.300	3000	Width 1.050 Depth 750 Height 1.300	Width 1.150 Depth 975 Height 1.330	
RCU 3000	-	-	-	Width 1.250 Depth 1.500 Height 1.300	Width 1.800 Depth 1.450 Height 1.300	

### ACCESSORIES ACCESSORI

INCLUSO	OPTIONAL (NON INCLUSO)
 WATER INLET FILTER GASKET GIUNTURA DEL FILTRO DI INGRESSO DELL'ACQUA	 ICE DROP CHUTE TUBO DI FUORIUSCITA DEL GHIACCIO
 WATER INLET HOSE TUBO INGRESSO DELL'ACQUA	 SALT DOSING PUMP WITH TANK BOMBA DOSATORE DI SALE CON DEPOSITO
 WATER OUTLET HOSE TUBO DI SCARICO	 REMOTE SWITCH INTERRUTTORE REMOTO
	 REMOTE SWITCH & WEEKLY PROGRAMMER INTERRUTTORE REMOTO CON TIMER SETTIMANALE
	 EXTERNAL STOP FULL BIN PHOTO CELL SENSORE DI ARRESTO ESTERNO PER RIEMPIMENTO
	 Y EXTENSION INOX ESTENSIONI Y INOX

### RECOMMENDED BINS SERBATOIO RACCOMANDATI



S500 + SCALA 3000 SPLIT

SCD400 + SCALA 3000 SPLIT

SCD600 + SCALA 3000 SPLIT

SCD800 + SCALA 3000 SPLIT

SS221 + SCALA 3000 C02 SPLIT

SS422 + SCALA 3000 C02 SPLIT

SCALA 3000 SPLIT

RIGHT SIDE VIEW  
VISTA LATERALE DESTRA

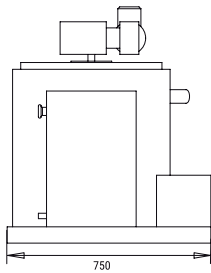

FRONTAL VIEW  
VISTA FRONTALE

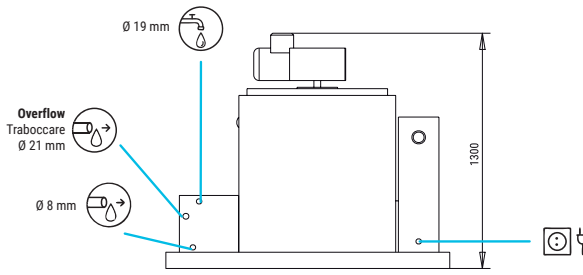

LEFT SIDE VIEW  
VISTA LATERALE SINISTRA

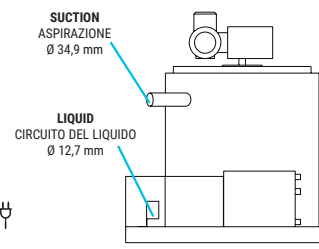

RCU 3000

CENTRAL CROSS SECTION VIEW OF THE BASE  
VISTA DELLA BASE DALLA ZONA CENTRALE

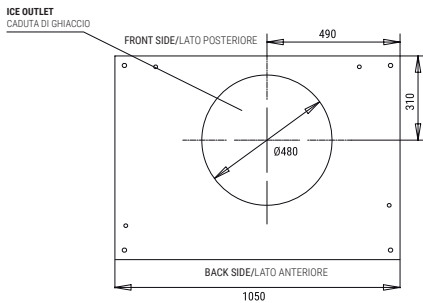

RIGHT SIDE VIEW  
VISTA LATERALE DESTRA

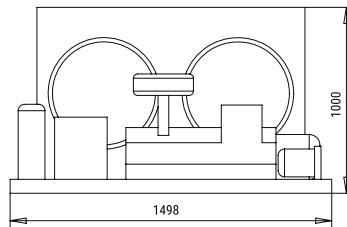

RIGHT SIDE VIEW  
VISTA LATERALE DESTRA

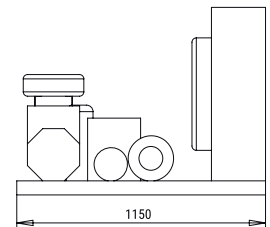

\* All measurements in mm.  
\* Tutte le misure in mm.

OPERATING CONDITIONS CONDIZIONI PER IL FUNZIONAMENTO

PRODUCTION 50Hz PRODUZIONE 50 Hz

±10% V

10°C/43°C

5°C/38°C

1 bar/6 bar

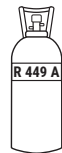

V	Hz	ph
400	50	3N

SCALA 3000 REMOTE

°C	10°	15°	21°	30°
°F	50°	60°	70°	86°
10°	3300	3100	2700	2500
50°				
21°	3270	3000	2600	2370
68°				
32°	3100	2800	2400	2150
90°				
43°	2550	2370	1950	1800
109°				

SCALA 3000 REMOTE

°C	10°	15°	21°	30°
°F	50°	60°	70°	86°
10°	3069	2883	2511	2325
50°				
21°	3041	2790	2418	2204
68°				
32°	2883	2604	2232	2000
90°				
43°	2372	2204	1814	1674
109°				

MODELS  
MODELLI

	Temp.EV. (°C)	ASHRAE CONDITIONS CONDIZIONI ASHRAE (W) (BTU/h)	(W) 43°C	(n.) (mm <sup>2</sup> )	FUSE	100 Kg (Kw/h)	(l/h)	HEAT REJECTED (W) (BTU/h)	(Kg)	(Kg)	(m <sup>3</sup> )
SCALA 3000 S	-22	16.500 56.300	200	3 6	32	7,8	16,6	- -	280	320	1,27
RCU 3000	-	- -	12.150	5 6	32	-	-	19.800 67.560	360	400	2,64



ITV ICE MAKERS, S.L.  
POL. IND. SECTOR 13, AVDA. DELS HOSTALERS, 2  
46394 RIBARROJA DE TURIA, VALENCIA, SPAIN  
PHONE: +34 96 166 75 75 | FAX: +34 96 166 81 00  
info@itv.es | www.itv.es



SERVICE  
SERVIZIO ASSISTENZA TECNICA  
service@itv.es  
Skype: ITV.Service  
+34 961 667 639  
8:00AM | 7:00PM



Subject to certain limitations  
and exclusions. Only spare parts.  
Soggetta a limitazioni e revoca. Solo  
parti di ricambio.

