

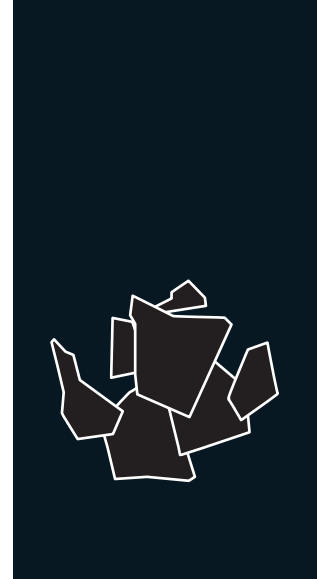







SCALA 1500 SPLIT 230 V / 50-60 Hz

MACHINE SPLIT À GLACE EN ÉCAILLES

FEATURES CARACTÉRISTIQUES

- ▶ **PRODUCES COLD AND DRY FLAT FLAKES. FLAKE THICKNESS MAY BE ADJUSTED BETWEEN 1.5 MM AND 3 MM.**
PRODUIT DES ÉCAILLES PLATES, TRÈS FROIDES ET SÈCHES. L'ÉPAISSEUR PEUT SE RÉGLER ENTRE 1,5 MM ET 3 MM.
- ▶ **BASED ON A STATIC CYLINDER WHICH IS FREE FROM SWIVEL JOINTS (HELICAL REAMER) COUPLED WITH A MILLING TOOL THAT DETACHES THE ICE WITHOUT ANY STRAINED OR FORCED MOVEMENTS.**
FONCTIONNEMENT BASÉ SUR UN CYLINDRE STATIQUE SANS JOINTS TOURNANTS (HELICAL REAMER) ET AVEC UNE FRAISE QUI DÉCOLLE LA GLACE SANS TENSION NI EFFORTS.
- ▶ **THE MOST EFFICIENT EVAPORATOR OF THE MARKET, LESS ENERGY CONSUMPTION AND HIGHER ICE PRODUCTION.**
L'ÉVAPORATEUR LE PLUS EFFICACE DU MARCHÉ, MOINS DE DÉPENSES ÉNERGÉTIQUES, PLUS PRODUCTION DE GLAÇONS.
- ▶ **THERMOSTATIC EXPANSION VALVE / LIQUID SOLENOID VALVE / STOP WHEN FULL BIN STOP WITH PHOTOELECTRICAL SENSOR.**
DÉTENDEUR THERMOSTATIQUE / ÉLECTROVANNE DE LIQUIDE / ARRÊT PAR REMPLISSAGE DE CUVE AVEC CELLULE PHOTOÉLECTRIQUE.
- ▶ **ELECTRONIC STOP SYSTEM / ELECTRICAL CONTROL PANEL / DRIVE DIRECT GEAR MOTOR / MAGNETIC DRIVE PUMP / LOW WATER SAFETY DEVICE.**
SYSTÈME D'ARRÊT ÉLECTRONIQUE / TABLEAU ÉLECTRIQUE DE RÉGLAGE / MOTORÉDUCTEUR D'ATTAQUE DIRECT / POMPE À ENTRAÎNEMENT MAGNÉTIQUE / SÉCURITÉ EN CAS DE MANQUE D'EAU.
- ▶ **STAINLESS STEEL SOLEPLATE.**
BÂTI EN ACIER INOXYDABLE.
- ▶ **CONTROLLERS TO DETECT: LOW WATER LEVEL, TEMPERATURE RISE DUE TO MOTOR OVERLOAD OR FULL VAT.**
CONTRÔLES POUR DÉTECTION : MANQUE DE NIVEAU D'EAU, AUGMENTATION DE TEMPÉRATURE POUR CAUSE D'EFFORTS EXCESSIFS DANS LE MOTORÉDUCTEUR OU DE REMPLISSAGE DU RÉSERVOIR.

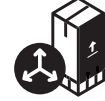

	 24 H	 10°C	 10°C	 21°C	 15°C	 (mm)	 (mm)	
SCALA 1500 SPLIT 		1.650	1.500	Width 1.050 Depth 750 Height 1.060	Width 1.150 Depth 850 Height 1.180	FLAKE ICE -7°C Ice Temperature		

ACCESSORIES ACCESSOIRES

INCLUDED



WATER INLET FILTER GASKET
JOINT DE FILTRE D'ENTRÉE D'EAU



WATER INLET HOSE
TUYAU D'ENTRÉE D'EAU



WATER OUTLET HOSE
TUYAU D'ÉVACUATION

OPTIONAL (NOT INCLUDED)



ICE DROP CHUTE
TUYAU DE CHUTE DES GLAÇONS



SALT DOSING PUMP WITH TANK
POMPE DE DOSAGE DE SEL AVEC DÉPÔT



REMOTE SWITCH
INTERRUPTEUR À DISTANCE



REMOTE SWITCH & WEEKLY PROGRAMMER
INTERRUPTEUR AVEC PROGRAMMEUR HEBDOMADAIRE



EXTERNAL STOP FULL BIN PHOTO CELL
CAPTEUR D'ARRÊT EXTERNE PAR REMPLISSAGE

RECOMMENDED BINS RÉSERVOIRS CONSEILLÉS



S500 + SCALA 1500 SPLIT



SCD400 + SCALA 1500 SPLIT



SCD600 + SCALA 1500 SPLIT



SCD800 + SCALA 1500 SPLIT



SS221 + SCALA 1500 SPLIT

SCALA 1500 SPLIT

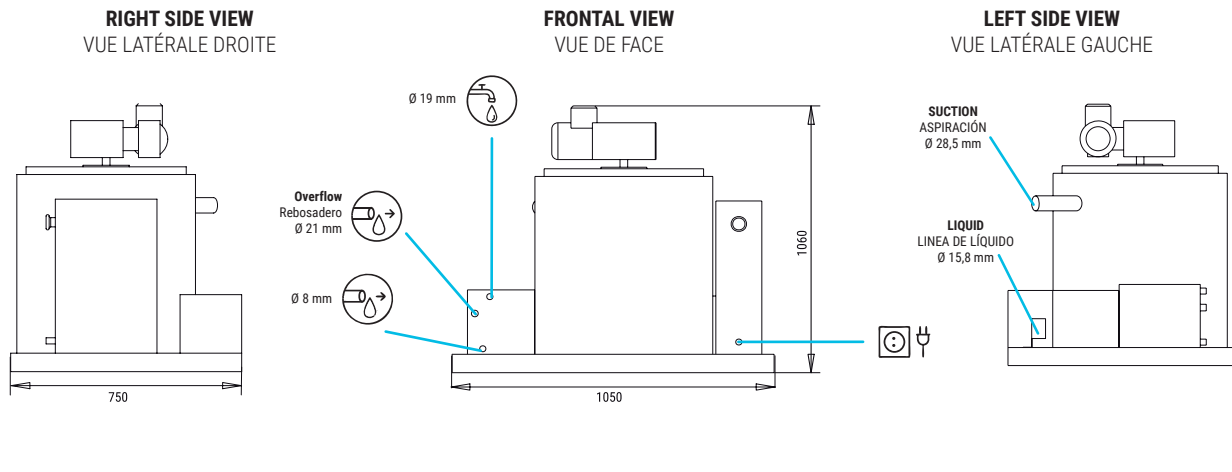

CENTRAL CROSS SECTION VIEW OF THE BASE
VUE DE LA BASE DEPUIS LA SECTION CENTRALE

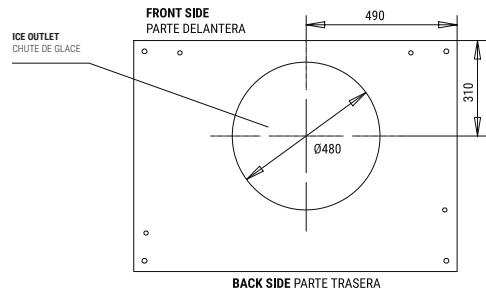

*All measurements in mm.
*Toutes les cotes sont en mm.

OPERATING CONDITIONS CONDITIONS DE FONCTIONNEMENT

PRODUCTION 50Hz/60Hz PRODUCTIONS 50-60 Hz

Icon	Value	SCALA 1500 SPLIT (1'5"2'2 mm)					SCALA 1500 SPLIT (3 mm)				
		10°	15°	21°	30°	10°	15°	21°	30°		
⚡	±10% V										
🏠	10°C/43°C										
🌡️	5°C/38°C										
💧	1 bar/6 bar										
📦	R 449 A										
🌡️	10°	1650	1575	1350	1240	1535	1465	1256	1153		
🌡️	50°	1600	1500	1290	1190	1488	1395	1200	1107		
🌡️	21°	1520	1400	1200	1100	1414	1302	1116	1023		
🌡️	68°	1280	1180	950	900	1190	1097	884	837		
🌡️	32°										
🌡️	90°										
🌡️	43°										
🌡️	109°										

MODÈLES

Model	Temp. EV (°C)	Cooling Requirement (W)	Cooling Requirement (BTU/h)	(W) 43°C	(n.)	(mm²)	FUSE	100 Kg (Kw/h)	(l/h)	HEAT REJECTED (W)	HEAT REJECTED (BTU/h)	(Kg)	(Kg)	(m³)
SCALA 1500 S	-22	8.250	28.150	200	3	1,5	16	10,3*	62,5	-	-	200	260	1.15

* WHEN INDICATED COOL REQUIREMENT IS SUPPLIED / LORSQUE LA CAPACITÉ DE REFRIGÉRISSMENT REQUISE EST FOURNIE



ITV ICE MAKERS, S.L.
POL. IND. SECTOR 13, AVDA. DELS HOSTALERS, 2
46394 RIBARROJA DE TURIA, VALENCIA, SPAIN
PHONE: +34 96 166 75 75 | FAX: +34 96 166 81 00
info@itv.es | www.itv.es



SERVICE SERVICE D'ASSISTANCE TECHNIQUE
service@itv.es
Skype: ITV.Service
+34 961 667 639
8:00AM | 7:00PM



Subject to certain limitations and exclusions. Only spare parts.
Sujet à limitations et exclusions. Pièces de rechange uniquement.

