

SCALA 1500 REMOTE

THREE PHASE
400 V / 50 Hz

MODULAR FLAKE ICE MACHINE WITH REMOTE UNIT

FEATURES CARATTERISTICHE

- ▶ **PRODUCES COLD AND DRY FLAT FLAKES. FLAKE THICKNESS MAY BE ADJUSTED BETWEEN 1.5 mm AND 3 mm**
PRODUCE SCAGLIE PIANE MOLTO FREDDI E ASCIUTTE. LO SPESSORE È REGOLABILE DA 1.5 A 3 mm
- ▶ **BASED ON A STATIC CYLINDER WHICH IS FREE FROM SWIVEL JOINTS (HELICAL REAMER) COUPLED WITH A MILLING TOOL THAT DETACHES THE ICE WITHOUT ANY STRAINED OR FORCED MOVEMENTS**
FUNZIONAMENTO BASATO SU UN CILINDRO STATICO SENZA GIUNTI ROTANTI (ALESATORE ELICOIDALE) E CON UNA FRESA CHE STACCA IL GHIACCIO SENZA TENSIONE O SFORZO
- ▶ **THE MOST EFFICIENT EVAPORATOR OF THE MARKET, LESS ENERGY CONSUMPTION AND HIGHER ICE PRODUCTION**
L'EVAPORATORE PIÙ EFFICIENTE SUL MERCATO, CONSUMO ENERGETICO MINORE, MAGGIORE PRODUZIONE DI GHIACCIO
- ▶ **ELECTRONIC STOP SYSTEM / ELECTRICAL CONTROL PANEL / DRIVE DIRECT GEAR MOTOR / MAGNETIC DRIVE PUMP / LOW WATER SAFETY DEVICE**
SISTEMA ELETTRONICO DI ARRESTO / PANNELLO DI CONTROLLO ELETTRICO / MOTORIDUTTORE CON TRASMISSIONE DIRETTA / POMPA A TRASCINAMENTO MAGNETICO / DISPOSITIVO DI SICUREZZA IN CASO DI MANCANZA DI ACQUA
- ▶ **STAINLESS STEEL SOLEPLATE**
PIASTRA IN ACCIAIO INOSSIDABILE
- ▶ **CONTROLLERS TO DETECT: LOW WATER LEVEL, TEMPERATURE RISE DUE TO MOTOR OVERLOAD OR FULL VAT**
DISPOSITIVI PER RILEVARE: MANCANZA DI ACQUA, AUMENTO DELLA TEMPERATURA A CAUSA DEL SOVRACCARICO DEL MOTORE O PER RIEMPIMENTO DELLA VASCHETTA

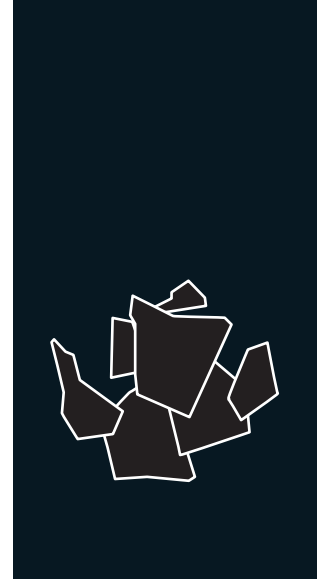

	24 H	10°C (Kg)	15°C (Kg)	(mm)	(mm)	FLAKE ICE -7°C Ice Temperature
SCALA 1500 SPLIT		1.650	1.500	Width 1.050 Depth 750 Height 1.060	Width 1.150 Depth 850 Height 1.190	
RCU 1500	-	-	-	Width 1.613 Depth 574 Height 1.297	Width 1.780 Depth 730 Height 1.620	

ACCESSORIES ACCESSORI

INCLUSO			OPTIONAL (NON INCLUSO)				
WATER INLET FILTER GASKET GIUNTA DEL FILTRO DI INGRESSO DELL'ACQUA	WATER INLET HOSE TUBO INGRESSO DELL'ACQUA	WATER OUTLET HOSE TUBO DI SCARICO	ICE DROP CHUTE TUBO DI FUORIUSCITA DEL GHIACCIO	SALT DOSING PUMP WITH TANK BOMBA DOSATORE DI SALE CON DEPOSITO	REMOTE SWITCH INTERRUTTORE REMOTO	REMOTE SWITCH & WEEKLY PROGRAMMER INTERRUTTORE REMOTO CON TIMER SETTIMANALE	EXTERNAL STOP FULL BIN PHOTO CELL SENSORE DI ARRESTO ESTERNO PER RIEMPIMENTO

RECOMMENDED BINS SERBATOIO RACCOMANDATI



S500 + SCALA 1500 SPLIT

SCD400 + SCALA 1500 SPLIT

SCD600 + SCALA 1500 SPLIT

SCD800 + SCALA 1500 SPLIT

SS221 + SCALA 1000 CO2 SPLIT

SCALA 1500 SPLIT

RIGHT SIDE VIEW
VISTA LATERALE DESTRA

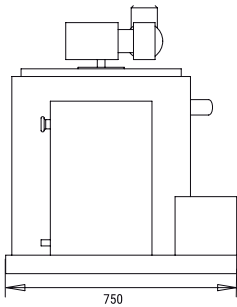

FRONTAL VIEW
VISTA FRONTALE

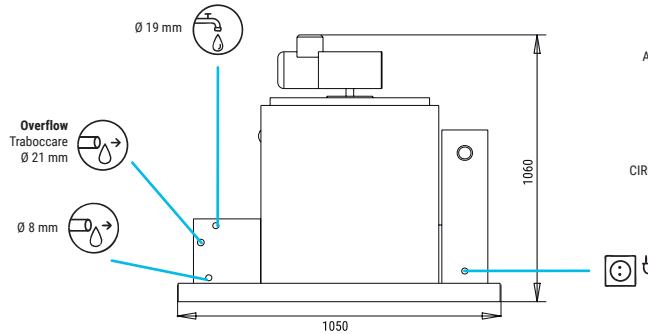

LEFT SIDE VIEW
VISTA LATERALE SINISTRA

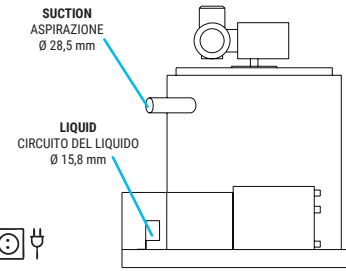

RCU 1500

CENTRAL CROSS SECTION VIEW OF THE BASE
VISTA DELLA BASE DALLA ZONA CENTRALE

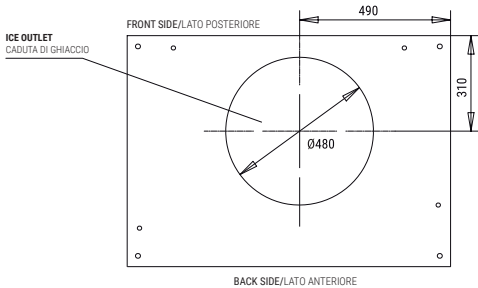

REAR VIEW
VISTA POSTERIORE

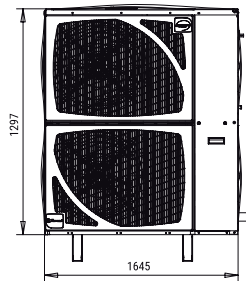

RIGHT SIDE VIEW
VISTA LATERALE DESTRA

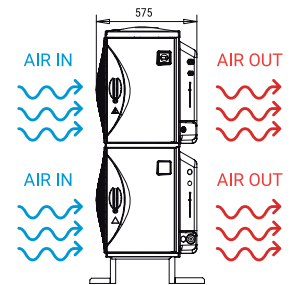

* All measurements in mm.
* Tutte le misure in mm.

OPERATING CONDITIONS CONDIZIONI PER IL FUNZIONAMENTO

PRODUCTION 50Hz PRODUZIONE 50 Hz

±10% V

10°C/43°C

5°C/38°C

1 bar/6 bar

V	Hz	ph
400	50	3N

SCALA 1500 REMOTE

°C	10°	15°	21°	30°
°F	50°	60°	70°	86°
10°	1650	1575	1350	1240
50°				
21°	1600	1500	1290	1190
68°				
32°	1520	1400	1200	1100
90°				
43°	1280	1180	950	900
109°				

SCALA 1500 REMOTE

°C	10°	15°	21°	30°
°F	50°	60°	70°	86°
10°	1535	1465	1256	1153
50°				
21°	1488	1395	1200	1107
68°				
32°	1414	1302	1116	1023
90°				
43°	1190	1097	884	837
109°				

MODELS
MODELLI

	Temp.EV. (°C)	ASHRAE CONDITIONS CONDIZIONI ASHRAE (W) (BTU/h)	(W) 43°C	(n.) (mm ²)	FUSE	100 Kg (Kw/h)	(l/h)	HEAT REJECTED (W) (BTU/h)	(Kg)	(Kg)	(m ³)
SCALA 1500 S	-22	8.250 28.150	200	3 4	16	10,3	62,5	- -	200	260	1,15
RCU 1500	-	- -	6.440	5 4	16	-	-	9.900 33.780	308	328	2,10



ITV ICE MAKERS, S.L.
POL. IND. SECTOR 13, AVDA. DELS HOSTALERS, 2
46394 RIBARROJA DE TURIA, VALENCIA, SPAIN
PHONE: +34 96 166 75 75 | FAX: +34 96 166 81 00
info@itv.es | www.itv.es



SERVICE
SERVIZIO ASSISTENZA TECNICA
service@itv.es
Skype: ITV.Service
+34 961 667 639
8:00AM | 7:00PM



Subject to certain limitations
and exclusions. Only spare parts.
Soggetta a limitazioni e revoca. Solo
parti di ricambio.

