

# SCALA 1500 REMOTE

THREE PHASE  
400 V / 50 Hz

## MODULAR FLAKE ICE MACHINE WITH REMOTE UNIT

### FEATURES CARACTÉRISTIQUES

- ▶ **PRODUCES COLD AND DRY FLAT FLAKES. FLAKE THICKNESS MAY BE ADJUSTED BETWEEN 1.5 MM AND 3 MM.**  
PRODUIT DES ÉCAILLES PLATES, TRÈS FROIDES ET SÈCHES. L'ÉPAISSEUR PEUT SE RÉGLER ENTRE 1,5 MM ET 3 MM.
- ▶ **BASED ON A STATIC CYLINDER WHICH IS FREE FROM SWIVEL JOINTS (HELICAL REAMER) COUPLED WITH A MILLING TOOL THAT DETACHES THE ICE WITHOUT ANY STRAINED OR FORCED MOVEMENTS.**  
FONCTIONNEMENT BASÉ SUR UN CYLINDRE STATIQUE SANS JOINTS TOURNANTS (HELICAL REAMER) ET AVEC UNE FRAISE QUI DÉCOLLE LA GLACE SANS TENSION NI EFFORTS.
- ▶ **THE MOST EFFICIENT EVAPORATOR OF THE MARKET, LESS ENERGY CONSUMPTION AND HIGHER ICE PRODUCTION.**  
L'ÉVAPORATEUR LE PLUS EFFICACE DU MARCHÉ, MOINS DE DÉPENSES ÉNERGÉTIQUES, PLUS PRODUCTION DE GLAÇONS.
- ▶ **ELECTRONIC STOP SYSTEM / ELECTRICAL CONTROL PANEL / DRIVE DIRECT GEAR MOTOR / MAGNETIC DRIVE PUMP / LOW WATER SAFETY DEVICE.**  
SYSTÈME D'ARRÊT ÉLECTRONIQUE / TABLEAU ÉLECTRIQUE DE RÉGLAGE / MOTORÉDUCTEUR D'ATTAQUE DIRECT / POMPE À ENTRAÎNEMENT MAGNÉTIQUE / SÉCURITÉ EN CAS DE MANQUE D'EAU.
- ▶ **STAINLESS STEEL SOLEPLATE.**  
BÂTI EN ACIER INOXYDABLE.
- ▶ **CONTROLLERS TO DETECT: LOW WATER LEVEL, TEMPERATURE RISE DUE TO MOTOR OVERLOAD OR FULL VAT.**  
CONTRÔLES POUR DÉTECTION : MANQUE DE NIVEAU D'EAU, AUGMENTATION DE TEMPÉRATURE POUR CAUSE D'EFFORTS EXCESSIFS DANS LE MOTORÉDUCTEUR OU DE REMPLISSAGE DU RÉSERVOIR.

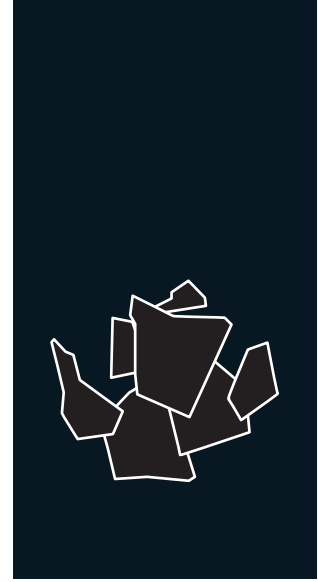

	24 H	10°C (Kg)	15°C (Kg)	(mm)	(mm)	<b>FLAKE ICE</b> -7°C Ice Temperature
SCALA 1500 SPLIT		1.650	1.500	Width 1.050 Depth 750 Height 1.060	Width 1.150 Depth 850 Height 1.190	
RCU 1500	-	-	-	Width 1.613 Depth 574 Height 1.297	Width 1.780 Depth 730 Height 1.620	

### ACCESSORIES ACCESSOIRES

#### INCLUDED



**WATER INLET FILTER GASKET**  
JOINT DE FILTRE D'ENTRÉE D'EAU

**WATER INLET HOSE**  
TUYAU D'ENTRÉE D'EAU

**WATER OUTLET HOSE**  
TUYAU D'ÉVACUATION

#### OPTIONAL (NOT INCLUDED)



**ICE DROP CHUTE**  
TUYAU DE CHUTE DES GLAÇONS

**SALT DOSING PUMP WITH TANK**  
POMPE DE DOSAGE DE SEL AVEC DÉPÔT

**REMOTE SWITCH**  
INTERRUPTEUR À DISTANCE

**REMOTE SWITCH & WEEKLY PROGRAMMER**  
INTERRUPTEUR AVEC PROGRAMMEUR HEBDOMADAIRE

**EXTERNAL STOP FULL BIN PHOTO CELL**  
CAPTEUR D'ARRÊT EXTERNE PAR REMPLISSAGE

### RECOMMENDED BINS RÉSERVOIRS CONSEILLÉS



S500 + SCALA 1500 SPLIT



SCD400 + SCALA 1500 SPLIT



SCD600 + SCALA 1500 SPLIT



SCD800 + SCALA 1500 SPLIT



SS221 + SCALA 1000 CO2 SPLIT

SCALA 1500 SPLIT

RIGHT SIDE VIEW  
VUE LATÉRALE DROITE

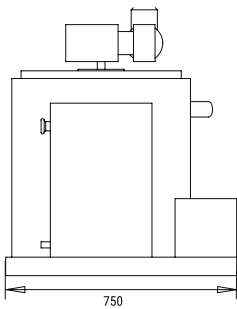

FRONTAL VIEW  
VUE DE FACE

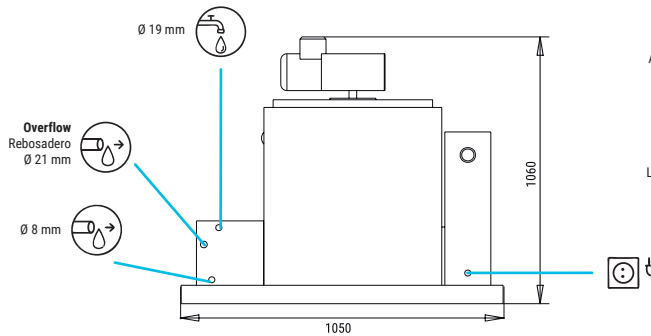

LEFT SIDE VIEW  
VUE LATÉRALE GAUCHE

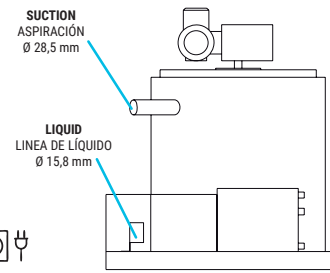

RCU 1500

CENTRAL CROSS SECTION VIEW OF THE BASE  
VUE DE LA BASE DEPUIS LA SECTION CENTRALE

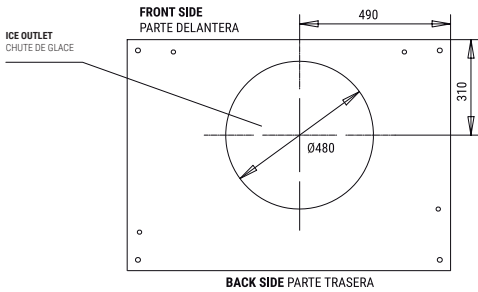

RIGHT SIDE VIEW  
VUE LATÉRALE DROITE

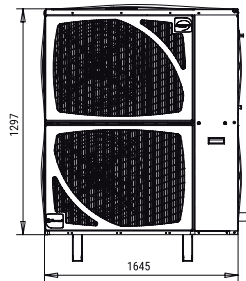

RIGHT SIDE VIEW  
VUE LATÉRALE DROITE

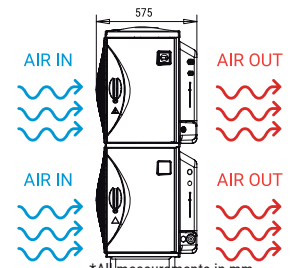

\*All measurements in mm.  
\*Toutes les cotes sont en mm.

OPERATING CONDITIONS CONDITIONS DE FONCTIONNEMENT

PRODUCTION 50Hz PRODUCTION 50 Hz

±10% V

10°C/43°C

5°C/38°C

1 bar/6 bar

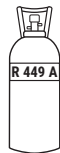

V	Hz	ph
400	50	3N

SCALA 1500 REMOTE

°C °F	1'5-2'2 mm			
	10° 50°	15° 60°	21° 70°	30° 86°
10° 50°	1650	1575	1350	1240
21° 68°	1600	1500	1290	1190
32° 90°	1520	1400	1200	1100
43° 109°	1280	1180	950	900

SCALA 1500 REMOTE

°C °F	3 mm			
	10° 50°	15° 60°	21° 70°	30° 86°
10° 50°	1535	1465	1256	1153
21° 68°	1488	1395	1200	1107
32° 90°	1414	1302	1116	1023
43° 109°	1190	1097	884	837

MODÈLES

	Temp.EV. (°C)	ASHRAE CONDITIONS CONDITIONS ASHRAE (W) (BTU/h)	(W) 43°C	(n.) (mm <sup>2</sup> )	FUSE	100 Kg (Kw/h)	(l/h)	HEAT REJECTED (W) (BTU/h)	(Kg)	(Kg)	(m <sup>3</sup> )
SCALA 1500 S	-22	8.250 28.150	200	3 4	16	10,3	62,5	- -	200	260	1,15
RCU 1500	-	- -	6.440	5 4	16	-	-	9.900 33.780	308	328	2,10



ITV ICE MAKERS, S.L.  
POL. IND. SECTOR 13, AVDA. DELS HOSTALERS, 2  
46394 RIBARROJA DE TURIA, VALENCIA, SPAIN  
PHONE: +34 96 166 75 75 | FAX: +34 96 166 81 00  
info@itv.es | www.itv.es



SERVICE  
SERVICE D'ASSISTANCE TECHNIQUE  
service@itv.es  
Skype: ITV.Service  
+34 961 667 639  
8:00AM | 7:00PM



Subject to certain limitations  
and exclusions. Only spare parts.  
Sujet à limitations et exclusions.  
Pièces de rechange uniquement.

