





SCALA 1500 THREE PHASE 400 V / 50 Hz

MODULAR FLAKE ICE MACHINE

FEATURES CARATTERISTICHE

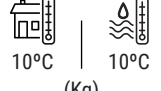
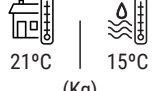
- ▶ **PRODUCES COLD AND DRY FLAT FLAKES. FLAKE THICKNESS MAY BE ADJUSTED BETWEEN 1.5 mm AND 3 mm**
▶ PRODUCE SCAGLIE PIANE MOLTO FREDDI E ASCIUTTE. LO SPESSORE È REGOLABILE DA 1.5 A 3 mm
- ▶ **BASED ON A STATIC CYLINDER WHICH IS FREE FROM SWIVEL JOINTS (HELICAL REAMER) COUPLED WITH A MILLING TOOL THAT DETACHES THE ICE WITHOUT ANY STRAINED OR FORCED MOVEMENTS**
▶ FUNZIONAMENTO BASATO SU UN CILINDRO STATICO SENZA GIUNTI ROTANTI (ALESATORE ELICOIDALE) E CON UNA FRESA CHE STACCA IL GHIACCIO SENZA TENSIONE O SFORZO
- ▶ **THE MOST EFFICIENT EVAPORATOR OF THE MARKET, LESS ENERGY CONSUMPTION AND HIGHER ICE PRODUCTION**
▶ L'EVAPORATORE PIÙ EFFICIENTE SUL MERCATO, CONSUMO ENERGETICO MINORE, MAGGIORE PRODUZIONE DI GHIACCIO
- ▶ **ELECTRONIC STOP SYSTEM / ELECTRICAL CONTROL PANEL / DRIVE DIRECT GEAR MOTOR / MAGNETIC DRIVE PUMP / LOW WATER SAFETY DEVICE**
▶ SISTEMA ELETTRONICO DI ARRESTO / PANNELLO DI CONTROLLO ELETTRICO / MOTORIDUTTORE CON TRASMISSIONE DIRETTA / POMPA A TRASCINAMENTO MAGNETICO / DISPOSITIVO DI SICUREZZA IN CASO DI MANCANZA DI ACQUA
- ▶ **STAINLESS STEEL SOLEPLATE**
▶ PIASTRA IN ACCIAIO INOSSIDABILE
- ▶ **CONTROLLERS TO DETECT: LOW WATER LEVEL, TEMPERATURE RISE DUE TO MOTOR OVERLOAD OR FULL VAT**
▶ DISPOSITIVI PER RILEVARE: MANCANZA DI ACQUA, AUMENTO DELLA TEMPERATURA A CAUSA DEL SOVRACCARICO DEL MOTORE O PER RIEMPIMENTO DELLA VASCHETTA



						
	24 H	10°C 10°C (Kg)	21°C 15°C (Kg)	(mm)	(mm)	FLAKE ICE -7°C Ice Temperature
SCALA 1500 		1.650	1.500	Width 1.405 Depth 1.645 Height 1.447	Width 1.575 Depth 1.785 Height 1.890	

ACCESSORIES ACCESSORI

INCLUSO			OPTIONAL (NON INCLUSO)				
							
WATER INLET FILTER GASKET GIUNTA DEL FILTRO DI INGRESSO DELL'ACQUA	WATER INLET HOSE TUBO INGRESSO DELL'ACQUA	WATER OUTLET HOSE TUBO DI SCARICO	ICE DROP CHUTE TUBO DI FUORIUSCITA DEL GHIACCIO	SALT DOSING PUMP WITH TANK BOMBA DOSATORE DI SALE CON DEPOSITO	REMOTE SWITCH INTERRUTTORE REMOTO	REMOTE SWITCH & WEEKLY PROGRAMMER INTERRUTTORE REMOTO CON TIMER SETTIMANALE	EXTERNAL STOP FULL BIN PHOTO CELL SENSORE DI ARRESTO ESTERNO PER RIEMPIMENTO

RECOMMENDED BINS SERBATOIO RACCOMANDATI



SS221 + SCALA 1500

SCALA 1500

REAR VIEW
VISTA POSTERIORE

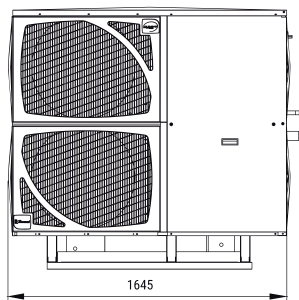

FRONTAL VIEW
VISTA FRONTALE

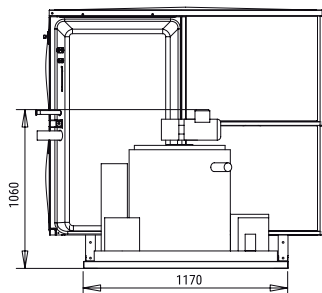

RIGHT SIDE VIEW
VISTA LATERALE DESTRA

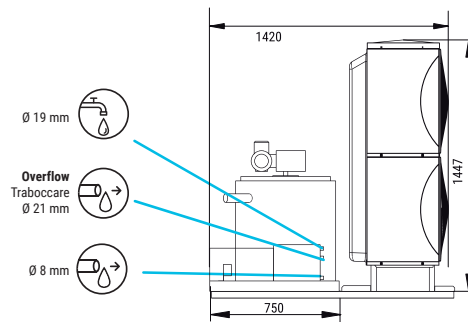

CENTRAL CROSS SECTION VIEW OF THE BASE
VISTA DELLA BASE DALLA ZONA CENTRALE

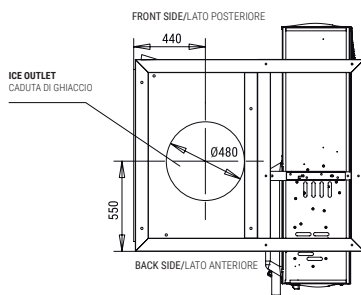

LEFT SIDE VIEW
VISTA LATERALE SINISTRA

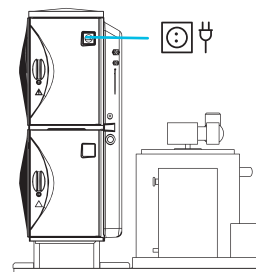

* All measurements in mm.
* Tutte le misure in mm.

OPERATING CONDITIONS CONDIZIONI PER IL FUNZIONAMENTO

PRODUCTION 50Hz PRODUZIONE 50 Hz

V	Hz	ph	SCALA 1500					SCALA 1500				
			10°	15°	21°	30°	10°	15°	21°	30°		
400	50	3N	1650	1575	1350	1240	1535	1465	1256	1153		
			1600	1500	1290	1190	1488	1395	1200	1107		
			1520	1400	1200	1100	1414	1302	1116	1023		
			1280	1180	950	900	1190	1097	884	837		

MODELS
MODELLI

SCALA 1500

Temp.EV. (°C)	ASHRAE CONDITIONS (W) (BTu/h)	(W) 43°C	(n.) (mm²)	FUSE	100 Kg (Kw/h)	(l/h)	HEAT REJECTED (W) (BTu/h)	(Kg)	(Kg)	(m³)
-22	8.250 28.150	6.640	5 4	16	10,3	62,5	9.900 33.780	490	550	5,31



ITV ICE MAKERS, S.L.
POL. IND. SECTOR 13, AVDA. DELS HOSTALERS, 2
46394 RIBARROJA DE TURIA, VALENCIA, SPAIN
PHONE: +34 96 166 75 75 | FAX: +34 96 166 81 00
info@itv.es | www.itv.es



SERVICE
SERVIZIO ASSISTENZA TECNICA
service@itv.es
Skype: ITV.Service
+34 961 667 639
8:00AM | 7:00PM



Subject to certain limitations
and exclusions. Only spare parts.
Soggetta a limitazioni e revoca. Solo
parti di ricambio.

