









SCALA 1500 THREE PHASE 400 V / 50 Hz

MACHINE À GLACE EN ÉCAILLES

FEATURES CARACTÉRISTIQUES

- ▶ **PRODUCES COLD AND DRY FLAT FLAKES. FLAKE THICKNESS MAY BE ADJUSTED BETWEEN 1.5 MM AND 3 MM.**
PRODUIT DES ÉCAILLES PLATES, TRÈS FROIDES ET SÈCHES. L'ÉPAISSEUR PEUT SE RÉGLER ENTRE 1,5 MM ET 3 MM.
- ▶ **BASED ON A STATIC CYLINDER WHICH IS FREE FROM SWIVEL JOINTS (HELICAL REAMER) COUPLED WITH A MILLING TOOL THAT DETACHES THE ICE WITHOUT ANY STRAINED OR FORCED MOVEMENTS.**
FONCTIONNEMENT BASÉ SUR UN CYLINDRE STATIQUE SANS JOINTS TOURNANTS (HELICAL REAMER) ET AVEC UNE FRAISE QUI DÉCOLLE LA GLACE SANS TENSION NI EFFORTS.
- ▶ **THE MOST EFFICIENT EVAPORATOR OF THE MARKET, LESS ENERGY CONSUMPTION AND HIGHER ICE PRODUCTION.**
L'ÉVAPORATEUR LE PLUS EFFICACE DU MARCHÉ, MOINS DE DÉPENSES ÉNERGÉTIQUES, PLUS PRODUCTION DE GLAÇONS.
- ▶ **ELECTRONIC STOP SYSTEM / ELECTRICAL CONTROL PANEL / DRIVE DIRECT GEAR MOTOR / MAGNETIC DRIVE PUMP / LOW WATER SAFETY DEVICE.**
SYSTÈME D'ARRÊT ÉLECTRONIQUE / TABLEAU ÉLECTRIQUE DE RÉGLAGE / MOTORÉDUCTEUR D'ATTAQUE DIRECT / POMPE À ENTRAÎNEMENT MAGNÉTIQUE / SÉCURITÉ EN CAS DE MANQUE D'EAU.
- ▶ **STAINLESS STEEL SOLEPLATE.**
BÂTI EN ACIER INOXYDABLE.
- ▶ **CONTROLLERS TO DETECT: LOW WATER LEVEL, TEMPERATURE RISE DUE TO MOTOR OVERLOAD OR FULL VAT.**
CONTRÔLES POUR DÉTECTION: MANQUE DE NIVEAU D'EAU, AUGMENTATION DE TEMPÉRATURE POUR CAUSE D'EFFORTS EXCESSIFS DANS LE MOTORÉDUCTEUR OU DE REMPLISSAGE DU RÉSERVOIR.



	 24 H	 10°C (Kg)	 10°C (Kg)	 21°C (Kg)	 15°C (Kg)	 (mm)	 (mm)	 FLAKE ICE -7°C Ice Temperature
SCALA 1500		1.650	1.500	Width 1.405 Depth 1.645 Height 1.447	Width 1.575 Depth 1.785 Height 1.890			

ACCESSORIES ACCESSOIRES

INCLUDED



WATER INLET FILTER GASKET
JOINT DE FILTRE D'ENTRÉE D'EAU

WATER INLET HOSE
TUYAU D'ENTRÉE D'EAU

WATER OUTLET HOSE
TUYAU D'ÉVACUATION

OPTIONAL (NOT INCLUDED)

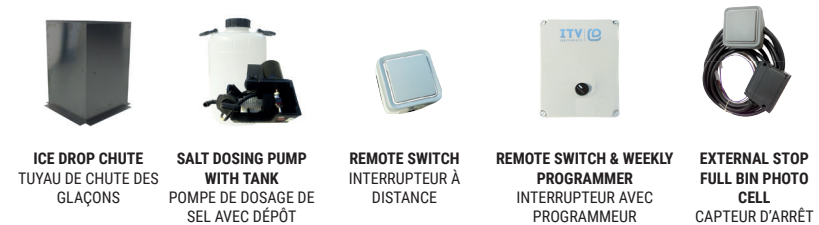

ICE DROP CHUTE
TUYAU DE CHUTE DES GLAÇONS

SALT DOSING PUMP WITH TANK
POMPE DE DOSAGE DE SEL AVEC DÉPÔT

REMOTE SWITCH
INTERRUPTEUR À DISTANCE

REMOTE SWITCH & WEEKLY PROGRAMMER
INTERRUPTEUR AVEC PROGRAMMEUR HEBDOMADAIRE

EXTERNAL STOP FULL BIN PHOTO CELL
CAPTEUR D'ARRÊT EXTERNE PAR REMPLISSAGE

RECOMMENDED BINS RÉSERVOIRS CONSEILLÉS



SS221 + SCALA 1500

SCALA 1500

RIGHT SIDE VIEW
VUE LATÉRALE DROITE

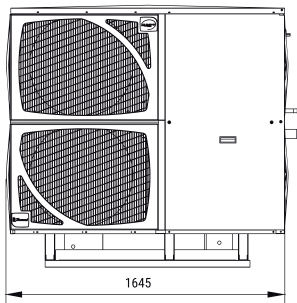

FRONTAL VIEW
VUE DE FACE

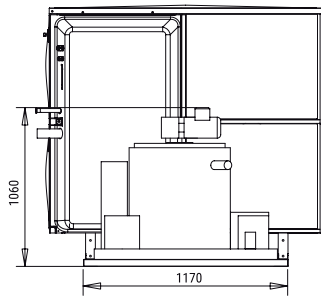

LEFT SIDE VIEW
VUE LATÉRALE GAUCHE

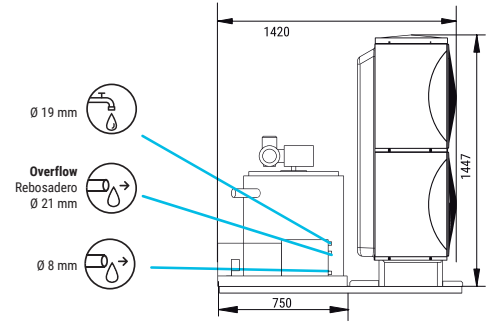

CENTRAL CROSS SECTION VIEW OF THE BASE
VUE DE LA BASE DEPUIS LA SECTION CENTRALE

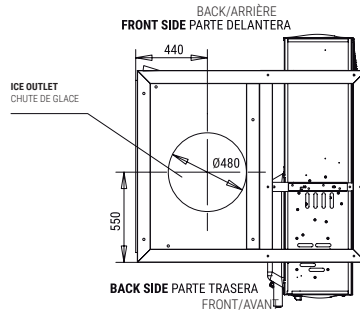

REAR VIEW
VISTA TRASERA

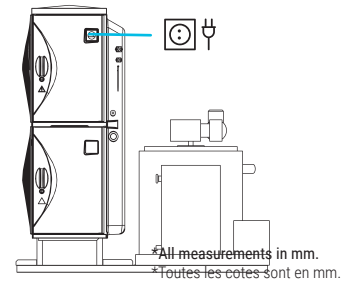

OPERATING CONDITIONS CONDITIONS DE FONCTIONNEMENT

PRODUCTION 50Hz PRODUCTION 50 Hz

Icon	Value	SCALA 1500					SCALA 1500						
		10°	15°	21°	30°	10°	15°	21°	30°				
⚡	±10% V	10°	15°	21°	30°	10°	15°	21°	30°	10°	15°	21°	30°
🌡️	10°C/43°C	50°	60°	70°	86°	50°	60°	70°	86°	50°	60°	70°	86°
🌊	5°C/38°C	1650	1575	1350	1240	1650	1500	1290	1190	1535	1465	1256	1153
💧	1 bar/6 bar	1600	1600	1290	1190	1488	1395	1200	1107	1414	1302	1116	1023
🔌	400 V 50 Hz 3N	1520	1400	1200	1100	1414	1302	1116	1023	1190	1097	884	837
🧊	R 449 A	1280	1180	950	900	1190	1097	884	837				

MODÈLES	Temp.EV. (°C)	ASHRAE CONDITIONS (W) (BTU/h)	(W) 43°C	(n.) (mm²)	FUSE	100 Kg (Kw/h)	(l/h)	HEAT REJECTED (W) (BTU/h)	(Kg)	(Kg)	(m³)
SCALA 1500	-22	8.250 28.150	6.640	5 4	16	10,3	62,5	9.900 33.780	490	550	5,31



ITV ICE MAKERS, S.L.
POL. IND. SECTOR 13, AVDA. DELS HOSTALERS, 2
46394 RIBARROJA DE TURIA, VALENCIA, SPAIN
PHONE: +34 96 166 75 75 | FAX: +34 96 166 81 00
info@itv.es | www.itv.es



SERVICE SERVICE D'ASSISTANCE TECHNIQUE
service@itv.es
Skype: ITV.Service
+34 961 667 639
8:00AM | 7:00PM



Subject to certain limitations and exclusions. Only spare parts.
Sujet à limitations et exclusions. Pièces de rechange uniquement.

