

SCALA 1000 REMOTE





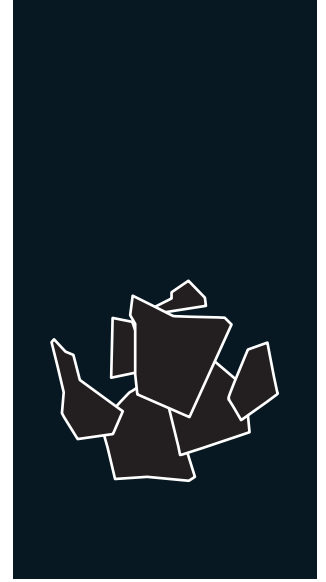

THREE PHASE
400 V / 50 Hz

MODULAR FLAKE ICE MACHINE WITH REMOTE UNIT

FEATURES CARATTERISTICHE

- ▶ **PRODUCES COLD AND DRY FLAT FLAKES. FLAKE THICKNESS MAY BE ADJUSTED BETWEEN 1.5 mm AND 3 mm**
PRODUCE SCAGLIE PIANE MOLTO FREDDI E ASCIUTTE. LO SPESSORE È REGOLABILE DA 1.5 A 3 mm
- ▶ **BASED ON A STATIC CYLINDER WHICH IS FREE FROM SWIVEL JOINTS (HELICAL REAMER) COUPLED WITH A MILLING TOOL THAT DETACHES THE ICE WITHOUT ANY STRAINED OR FORCED MOVEMENTS**
FUNZIONAMENTO BASATO SU UN CILINDRO STATICO SENZA GIUNTI ROTANTI (ALESATORE ELICOIDALE) E CON UNA FRESA CHE STACCA IL GHIACCIO SENZA TENSIONE O SFORZO
- ▶ **THE MOST EFFICIENT EVAPORATOR OF THE MARKET, LESS ENERGY CONSUMPTION AND HIGHER ICE PRODUCTION**
L'EVAPORATORE PIÙ EFFICIENTE SUL MERCATO, CONSUMO ENERGETICO MINORE, MAGGIORE PRODUZIONE DI GHIACCIO
- ▶ **ELECTRONIC STOP SYSTEM / ELECTRICAL CONTROL PANEL / DRIVE DIRECT GEAR MOTOR / MAGNETIC DRIVE PUMP / LOW WATER SAFETY DEVICE**
SISTEMA ELETTRONICO DI ARRESTO / PANNELLO DI CONTROLLO ELETTRICO / MOTORIDUTTORE CON TRASMISSIONE DIRETTA / POMPA A TRASCINAMENTO MAGNETICO / DISPOSITIVO DI SICUREZZA IN CASO DI MANCANZA DI ACQUA
- ▶ **STAINLESS STEEL SOLEPLATE**
PIASTRA IN ACCIAIO INOSSIDABILE
- ▶ **CONTROLLERS TO DETECT: LOW WATER LEVEL, TEMPERATURE RISE DUE TO MOTOR OVERLOAD OR FULL VAT**
DISPOSITIVI PER RILEVARE: MANCANZA DI ACQUA, AUMENTO DELLA TEMPERATURA A CAUSA DEL SOVRACCARICO DEL MOTORE O PER RIEMPIMENTO DELLA VASCHETTA

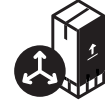

	 24 H	 10°C (Kg)	 15°C (Kg)	 (mm)	 (mm)	 FLAKE ICE -7°C Ice Temperature
SCALA 1000 SPLIT		1.100	1.000	Width 1.050 Depth 750 Height 870	Width 1.150 Depth 970 Height 1.010	
RCU 1000	-	-	-	Width 574 Depth 1.108 Height 1.319	Width 600 Depth 1.200 Height 1.500	

ACCESSORIES ACCESSORI

INCLUSO	OPTIONAL (NON INCLUSO)							
								
WATER INLET FILTER GASKET GIUNTA DEL FILTRO DI INGRESSO DELL'ACQUA	WATER INLET HOSE TUBO INGRESSO DELL'ACQUA	WATER OUTLET HOSE TUBO DI SCARICO	ICE DROP CHUTE TUBO DI FUORIUSCITA DEL GHIACCIO	SALT DOSING PUMP WITH TANK BOMBA DOSATORE DI SALE CON DEPOSITO	REMOTE SWITCH INTERRUTTORE REMOTO	REMOTE SWITCH & WEEKLY PROGRAMMER INTERRUTTORE REMOTO CON TIMER SETTIMANALE	EXTERNAL STOP FULL BIN PHOTO CELL SENSORE DI ARRESTO ESTERNO PER RIEMPIMENTO	Y EXTENSION INOX ESTENSION Y INOX

RECOMMENDED BINS SERBATOIO RACCOMANDATI



SCALA 1000 SPLIT

RIGHT SIDE VIEW
VISTA LATERALE DESTRA

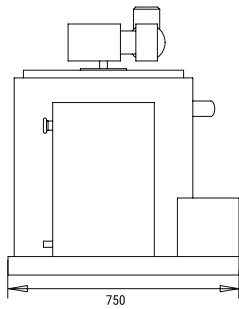

FRONTAL VIEW
VISTA FRONTALE

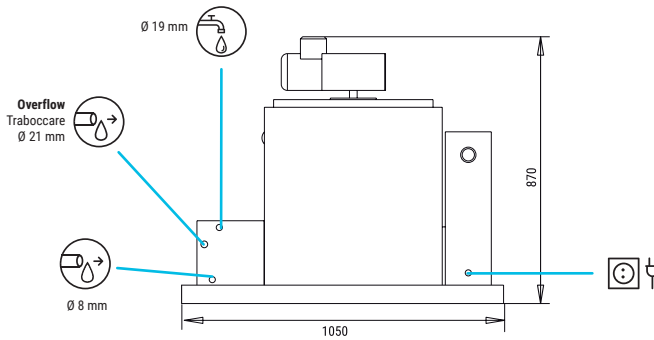

LEFT SIDE VIEW
VISTA LATERALE SINISTRA

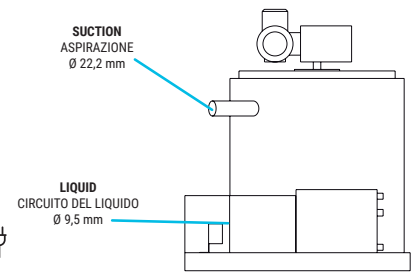

RCU 1000

CENTRAL CROSS SECTION VIEW OF THE BASE
VISTA DELLA BASE DALLA ZONA CENTRALE

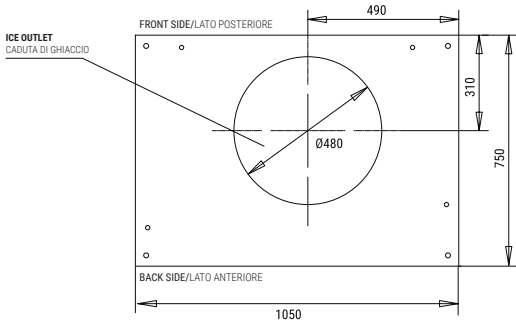

RIGHT SIDE VIEW
VISTA LATERALE DESTRA

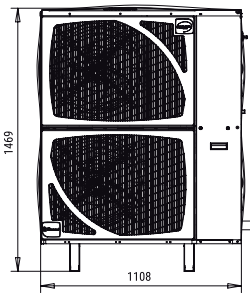

RIGHT SIDE VIEW
VISTA LATERALE DESTRA

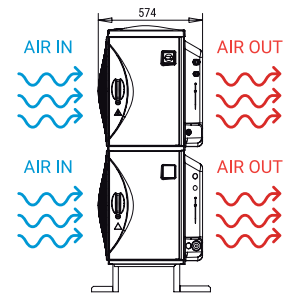

* All measurements in mm.
* Tutte le misure in mm.

OPERATING CONDITIONS CONDIZIONI PER IL FUNZIONAMENTO

PRODUCTION 50Hz PRODUZIONE 50 Hz

±10% V

10°C/43°C

5°C/38°C

1 bar/6 bar

V	Hz	ph
400	50	3N

°C	SCALA 1000 REMOTE			
	10°	15°	21°	30°
50°	1100	1400	900	830
21°	1090	1000	875	790
68°	1020	950	870	730
32°	860	780	650	600
90°				
43°				
109°				

MODELS
MODELLI

	Temp.EV. (°C)	ASHRAE CONDITIONS CONDIZIONI ASHRAE (W) (BTU/h)	(W) 43°C	(n.)	(mm ²)	FUSE	100 Kg (Kw/h)	(l/h)	HEAT REJECTED (W) (BTU/h)	(Kg)	(Kg)	(m ³)
SCALA 1000 S	-22	5.500 18.767	190	3	2,5	16	7,5	41,6	- -	170	200	1,13
RCU 1000	-	- -	2.395	5	2,5	16	-	-	6.600 22.520	129	149	1,08



ITV ICE MAKERS, S.L.
POL. IND. SECTOR 13, AVDA. DELS HOSTALERS, 2
46394 RIBARROJA DE TURIA, VALENCIA, SPAIN
PHONE: +34 96 166 75 75 | FAX: +34 96 166 81 00
info@itv.es | www.itv.es



SERVICE
SERVIZIO ASSISTENZA TECNICA
service@itv.es
Skype: ITV.Service
+34 961 667 639
8:00AM | 7:00PM



Subject to certain limitations
and exclusions. Only spare parts.
Soggetta a limitazioni e revoca. Solo
parti di ricambio.

