

## SCALA 1000







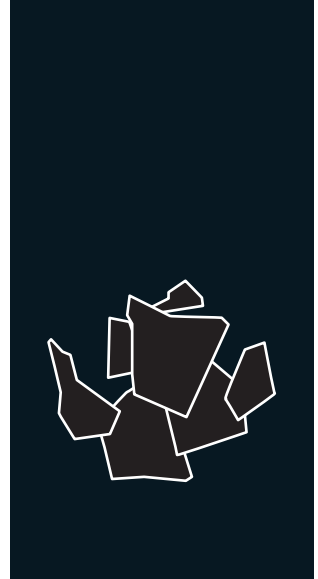

THREE PHASE  
400 V / 50 Hz

### MACHINE À GLACE EN ÉCAILLES

#### FEATURES CARACTÉRISTIQUES

- ▶ **PRODUCES COLD AND DRY FLAT FLAKES. FLAKE THICKNESS MAY BE ADJUSTED BETWEEN 1.5 MM AND 3 MM.**  
PRODUIT DES ÉCAILLES PLATES, TRÈS FROIDES ET SÈCHES. L'ÉPAISSEUR PEUT SE RÉGLER ENTRE 1,5 MM ET 3 MM.
- ▶ **BASED ON A STATIC CYLINDER WHICH IS FREE FROM SWIVEL JOINTS (HELICAL REAMER) COUPLED WITH A MILLING TOOL THAT DETACHES THE ICE WITHOUT ANY STRAINED OR FORCED MOVEMENTS.**  
FONCTIONNEMENT BASÉ SUR UN CYLINDRE STATIQUE SANS JOINTS TOURNANTS (HELICAL REAMER) ET AVEC UNE FRAISE QUI DÉCOLLE LA GLACE SANS TENSION NI EFFORTS.
- ▶ **THE MOST EFFICIENT EVAPORATOR OF THE MARKET, LESS ENERGY CONSUMPTION AND HIGHER ICE PRODUCTION.**  
L'ÉVAPORATEUR LE PLUS EFFICACE DU MARCHÉ, MOINS DE DÉPENSES ÉNERGÉTIQUES, PLUS PRODUCTION DE GLAÇONS.
- ▶ **ELECTRONIC STOP SYSTEM / ELECTRICAL CONTROL PANEL / DRIVE DIRECT GEAR MOTOR / MAGNETIC DRIVE PUMP / LOW WATER SAFETY DEVICE.**  
SYSTÈME D'ARRÊT ÉLECTRONIQUE / TABLEAU ÉLECTRIQUE DE RÉGLAGE / MOTORÉDUCTEUR D'ATTAQUE DIRECT / POMPE À ENTRAÎNEMENT MAGNÉTIQUE / SÉCURITÉ EN CAS DE MANQUE D'EAU.
- ▶ **STAINLESS STEEL SOLEPLATE.**  
BÂTI EN ACIER INOXYDABLE.
- ▶ **CONTROLLERS TO DETECT: LOW WATER LEVEL, TEMPERATURE RISE DUE TO MOTOR OVERLOAD OR FULL VAT.**  
CONTRÔLES POUR DÉTECTION: MANQUE DE NIVEAU D'EAU, AUGMENTATION DE TEMPÉRATURE POUR CAUSE D'EFFORTS EXCESSIFS DANS LE MOTORÉDUCTEUR OU DE REMPLISSAGE DU RÉSERVOIR.



	 24 H	 10°C (Kg)	 10°C (Kg)	 21°C (Kg)	 15°C (Kg)	 (mm)	 (mm)	
SCALA 1000		1.100	1.000	Width 1.360 Depth 1.050 Height 1.000	Width 1.580 Depth 1.290 Height 1.290	<b>FLAKE ICE</b> -7°C Ice Temperature		

#### ACCESSORIES ACCESORIOS

##### INCLUDED



##### OPTIONAL (NOT INCLUDED)

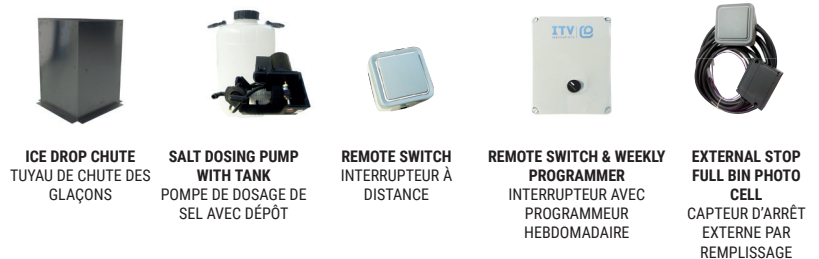

#### RECOMMENDED BINS RÉSERVOIRS CONSEILLÉS



SCALA 1000

RIGHT SIDE VIEW  
VUE LATÉRALE DROITE

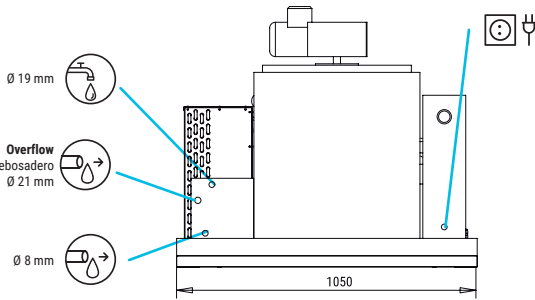

FRONTAL VIEW  
VUE DE FACE

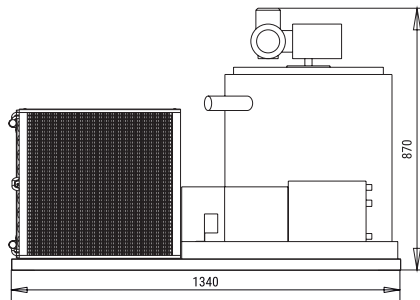

LEFT SIDE VIEW  
VUE LATÉRALE GAUCHE

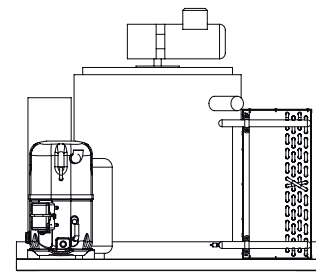

CENTRAL CROSS SECTION VIEW OF THE BASE  
VUE DE LA BASE DEPUIS LA SECTION CENTRALE

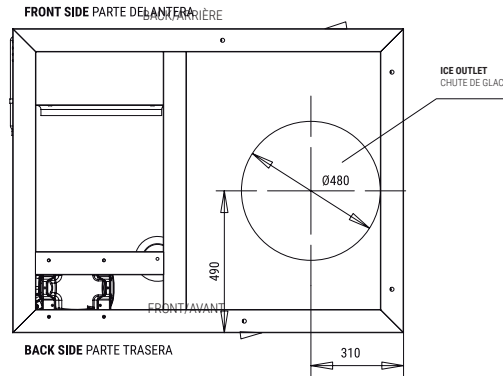

\*All measurements in mm.  
\*Toutes les cotes sont en mm.

OPERATING CONDITIONS CONDITIONS DE FONCTIONNEMENT

PRODUCTION 50Hz PRODUCTION 50 Hz

Voltage	Frequency	pH	SCALA 1000 (Ice 1'5"-2'2 mm)					SCALA 1000 (Ice 3 mm)				
			10°	15°	21°	30°	10°	15°	21°	30°		
±10% V	50 Hz	3N	1100	1400	900	830	1023	1302	837	772		
10°C/43°C			1090	1000	875	790	1014	930	814	735		
5°C/38°C			1020	950	800	730	949	884	744	679		
1 bar/6 bar			860	780	650	600	800	725	605	558		

MODÈLES

Model	Temp. EV (°C)	ASHRAE CONDITIONS (W) (BTU/h)	(W) 43°C	(n.)	(mm²)	FUSE	100 Kg (Kw/h)	(l/h)	HEAT REJECTED (W) (BTU/h)	(Kg)	(Kg)	(m³)
SCALA 1000	-22	5.500 18.767	2.585	5	2,5	16	7,5	41,6	6.600 22.520	249	353	2,63



ITV ICE MAKERS, S.L.  
POL. IND. SECTOR 13, AVDA. DELS HOSTALERS, 2  
46394 RIBARROJA DE TURIA, VALENCIA, SPAIN  
PHONE: +34 96 166 75 75 | FAX: +34 96 166 81 00  
info@itv.es | www.itv.es



SERVICE  
SERVICE D'ASSISTANCE TECHNIQUE  
service@itv.es  
Skype: ITV.Service  
+34 961 667 639  
8:00AM | 7:00PM



Subject to certain limitations and exclusions. Only spare parts.  
Sujet à limitations et exclusions.  
Pièces de rechange uniquement.

