

SCALA 10000 REMOTE





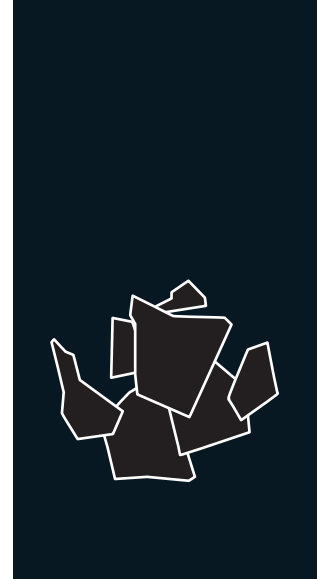

DREIPHASIG
400 V / 50 Hz

MODULARER SCHERBENEISBEREITER

EIGENSCHAFTEN

- ▶ PRODUZIERT SEHR KALTE UND TROCKENE SCHERBEN. DIE DICKE KANN ZWISCHEN 1,5 UND 3 MM REGULIERT WERDEN
- ▶ BETRIEB BASIERT AUF EINEM STATISCHEN ZYLINDER OHNE DREHGELENKE (HELICAL REAMER) ZUSAMMEN MIT EINEM FRÄSWERKZEUG, DAS DAS EIS OHNE BELASTUNG ODER ANSTRENGUNG ZERBRICHT
- ▶ DER EFFIZIENTESTE VERDAMPFER DES MARKTES, WENIGER ENERGIEVERBRAUCH UND HÖHERE EISPRODUKTION
- ▶ ELEKTRONISCHES STOP-SYSTEM / ELEKTRISCHE STEUERUNG / GETRIEBEMOTOR MIT DIREKTEM ANGRIFF / MAGNETISCHE ANTRIEBSPUMPE / NIEDRIGE WASSERSICHERHEITSVORRICHTUNG
- ▶ EDELSTAHL-SOLEPLATE
- ▶ KONTROLLEN FÜR: WASSERMANGEL, TEMPERATURERHÖHUNG DURCH ÜBERBELASTUNG DES GETRIEBEMOTORS ODER BEHÄLTERBEFÜLLUNG



	 24 H	 10°C (Kg)	 15°C (Kg)	 (mm)	 (mm)	 SCHERBENEIS -7°C Eistemperatur
SCALA 10000 SPLIT 	11.000	10.000		Breite 1.850 Tiefe 1.150 Höhe 1.800	Breite 1.910 Tiefe 1.230 Höhe 1.970	
RCU 10000	-	-		Breite 3.600 Tiefe 1.150 Höhe 1.600	Breite 3.800 Tiefe 1.470 Höhe 1.480	

ZUBEHÖR

EMPFOHLEN



SCHALTER
FERNBEDIENUNG



KIPPSCHALTER
FERNBEDIENUNG &
WOCHENPROGRAMMIERUNG



EXTERNER
KIPPSCHALTER MIT
PHOTOZELLENSTOPP
FÜR BEHÄLTER

EMPFOHLENE VORRATSBEHÄLTER



SS422 + SCALA 10000 CO2 SPLIT



SS623 + SCALA 10000 CO2 SPLIT



SS732 + SCALA 10000 CO2 SPLIT



SS1132 + SCALA 10000 CO2 SPLIT

TECHNISCHE DATEN



SCALA 10000 SPLIT

RECHTE SEITENSICHT

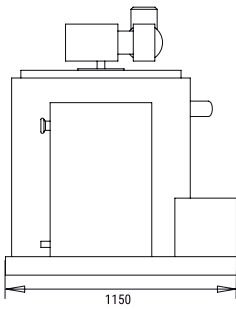

FRONTANSICHT

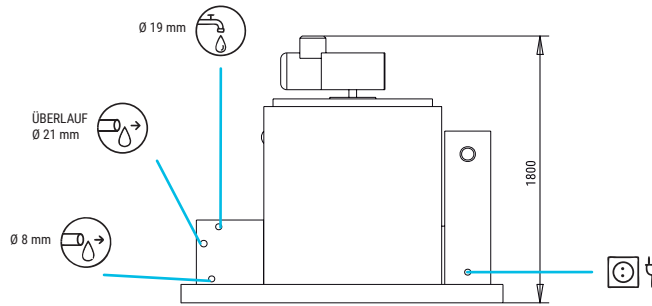

LINKE SEITENSICHT

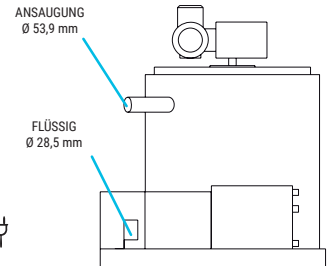

RCU 10000

QUERSCHNITT-ANSICHT DER BASIS

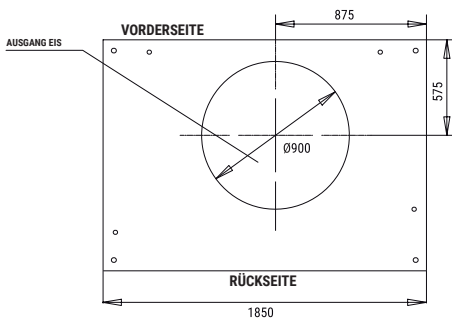

RECHTE SEITENSICHT

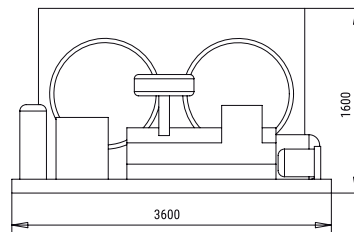

RECHTE SEITENSICHT

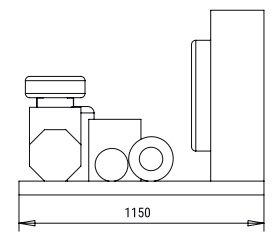

* Alle Größen in mm.

LEISTUNGEN

PRODUKTION 50Hz

±10% V

10°C/43°C

5°C/38°C

1 bar/6 bar



V	Hz	ph
400	50	3N

SCALA 10000 REMOTE

°C	10°	15°	21°	30°
°F	50°	60°	70°	86°
10°	11000	10400	9000	8250
50°	10800	10000	9750	7900
21°	10200	9450	8000	7200
68°	8700	7900	6500	6000
90°				
32°				
90°				
43°				
109°				

SCALA 10000 REMOTE

°C	10°	15°	21°	30°
°F	50°	60°	70°	86°
10°	11000	10400	9000	8250
50°	10800	10000	9750	7900
21°	10200	9450	8000	7200
68°	8700	7900	6500	6000
90°				
32°				
90°				
43°				
109°				

MODELLE

Temp.EV. (°C)	ASHRAE KONDITIONEN (W) (BTU/h)	(W) 43°C	(n.)	(mm ²)	FUSE	(100 Kg) (Kw/h)	(l/h)	(W) (BTU/h)	(Kg)	(Kg)	(m ³)	
SCALA 10000 S	-22	55.000 187.668	435	3	1,5	60	6,8	416,6	-	-	1.400	-
RCU 10000	-	-	30.600	5	10	60	-	-	66.000	225.201	471	510 8,20



ITV ICE MAKERS, S.L.
POL. IND. SECTOR 13, AVDA. DELS HOSTALERS, 2
46394 RIBARROJA DE TURIA, VALENCIA, SPAIN
PHONE: +34 96 166 75 75 | FAX: +34 96 166 81 00
info@itv.es | www.itv.es



SERVICE
service@itv.es
Skype: ITV.Service
+34 961 667 639
8:00AM | 7:00PM



Auf Teile und Lohn.
Vorbehaltlich bestimmter
Einschränkungen und
Auschlüsse.

