

## SCALA 10000

### MACHINE À GLACE EN ÉCAILLES

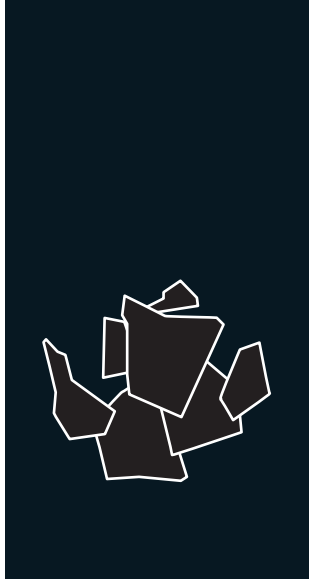







THREE PHASE  
400 V / 50 Hz



#### FEATURES CARACTÉRISTIQUES

- ▶ **PRODUCES COLD AND DRY FLAT FLAKES. FLAKE THICKNESS MAY BE ADJUSTED BETWEEN 1.5 MM AND 3 MM.**  
PRODUIT DES ÉCAILLES PLATES, TRÈS FROIDES ET SÈCHES. L'ÉPAISSEUR PEUT SE RÉGLER ENTRE 1,5 MM ET 3 MM.
- ▶ **BASED ON A STATIC CYLINDER WHICH IS FREE FROM SWIVEL JOINTS (HELICAL REAMER) COUPLED WITH A MILLING TOOL THAT DETACHES THE ICE WITHOUT ANY STRAINED OR FORCED MOVEMENTS.**  
FONCTIONNEMENT BASÉ SUR UN CYLINDRE STATIQUE SANS JOINTS TOURNANTS (HELICAL REAMER) ET AVEC UNE FRAISE QUI DÉCOLLE LA GLACE SANS TENSION NI EFFORTS.
- ▶ **THE MOST EFFICIENT EVAPORATOR OF THE MARKET, LESS ENERGY CONSUMPTION AND HIGHER ICE PRODUCTION.**  
L'ÉVAPORATEUR LE PLUS EFFICACE DU MARCHÉ, MOINS DE DÉPENSES ÉNERGÉTIQUES, PLUS PRODUCTION DE GLAÇONS.
- ▶ **ELECTRONIC STOP SYSTEM / ELECTRICAL CONTROL PANEL / DRIVE DIRECT GEAR MOTOR / MAGNETIC DRIVE PUMP / LOW WATER SAFETY DEVICE.**  
SYSTÈME D'ARRÊT ÉLECTRONIQUE / TABLEAU ÉLECTRIQUE DE RÉGLAGE / MOTORÉDUCTEUR D'ATTAQUE DIRECT / POMPE À ENTRAÎNEMENT MAGNÉTIQUE / SÉCURITÉ EN CAS DE MANQUE D'EAU.
- ▶ **STAINLESS STEEL SOLEPLATE.**  
BÂTI EN ACIER INOXYDABLE.
- ▶ **CONTROLLERS TO DETECT: LOW WATER LEVEL, TEMPERATURE RISE DUE TO MOTOR OVERLOAD OR FULL VAT.**  
CONTRÔLES POUR DÉTECTION: MANQUE DE NIVEAU D'EAU, AUGMENTATION DE TEMPÉRATURE POUR CAUSE D'EFFORTS EXCESSIFS DANS LE MOTORÉDUCTEUR OU DE REMPLISSAGE DU RÉSERVOIR.



	 24 H	 10°C	 10°C	 21°C	 15°C	 (mm)	 (mm)	
SCALA 10000		11.000	10.000	Width 5.575 Depth 1.300 Height 1.920	Width 5.980 Depth 1.800 Height 2.380	<b>FLAKE ICE</b> -7°C Ice Temperature		

#### ACCESSORIES ACCESSOIRES

OPTIONAL (NOT INCLUDED)



SALT DOSING PUMP WITH TANK  
POMPE DE DOSAGE DE SEL AVEC DÉPÔT



REMOTE SWITCH  
INTERRUPTEUR À DISTANCE



REMOTE SWITCH & WEEKLY PROGRAMMER  
INTERRUPTEUR AVEC PROGRAMMEUR HEBDOMADAIRE



EXTERNAL STOP FULL BIN PHOTO CELL  
CAPTEUR D'ARRÊT EXTERNE PAR REMPLISSAGE

#### RECOMMENDED BINS RÉSERVOIRS CONSEILLÉS



SS422 + SCALA 10000



SS623 + SCALA 10000



SS732 + SCALA 10000

SCALA 10000

**RIGHT SIDE VIEW**  
VUE LATÉRALE DROITE

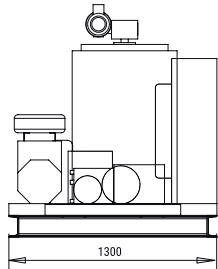

**FRONTAL VIEW**  
VUE DE FACE

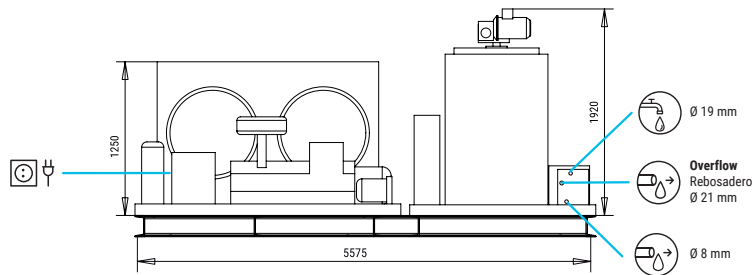

**LEFT SIDE VIEW**  
VUE LATÉRALE GAUCHE

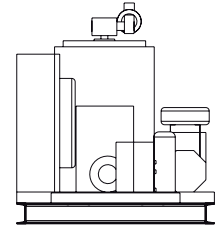

**CENTRAL CROSS SECTION VIEW OF THE BASE**  
VUE DE LA BASE DEPUIS LA SECTION CENTRALE

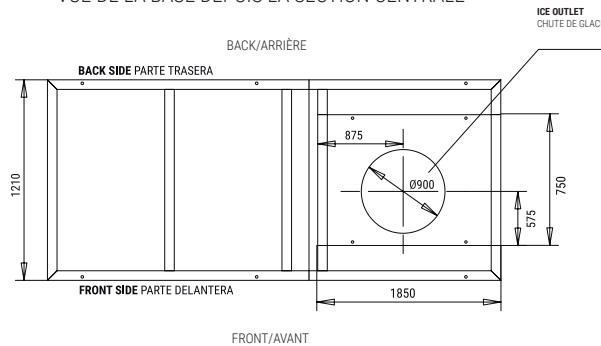

\*All measurements in mm.  
\*Toutes les cotes sont en mm.

## OPERATING CONDITIONS CONDITIONS DE FONCTIONNEMENT

PRODUCTION 50Hz PRODUCTION 50 Hz

Symbol	Value	SCALA 10000				
		10°	15°	21°	30°	
±10% V	±10% V	10°	15°	21°	30°	
10°C/43°C	10°C/43°C	50°	60°	70°	86°	
5°C/38°C	5°C/38°C	11000	10400	9000	8250	
1 bar/6 bar	1 bar/6 bar	10800	10000	9750	7900	
		10200	9450	8000	7200	
		8700	7900	6500	6000	

MODÈLES	Temp.EV. (°C)	ASHRAE CONDITIONS (W) (BTU/h)	(W) 43°C	(n.) (mm²)	FUSE	100 Kg (Kw/h)	(l/h)	HEAT REJECTED (W) (BTU/h)	(Kg)	(Kg)	(m³)
SCALA 10000	-22	55.000 187.668	31.035	5 16	60	6,8	416,6	66.000 225.201	1.950	2.050	25,62



ITV ICE MAKERS, S.L.  
POL. IND. SECTOR 13, AVDA. DELS HOSTALERS, 2  
46394 RIBARROJA DE TURIA, VALENCIA, SPAIN  
PHONE: +34 96 166 75 75 | FAX: +34 96 166 81 00  
info@itv.es | www.itv.es



SERVICE  
SERVICE D'ASSISTANCE TECHNIQUE  
service@itv.es  
Skype: ITV.Service  
+34 961 667 639  
8:00AM | 7:00PM



Subject to certain limitations and exclusions. Only spare parts.  
Sujet à limitations et exclusions.  
Pièces de rechange uniquement.

