

## QUASAR 50C









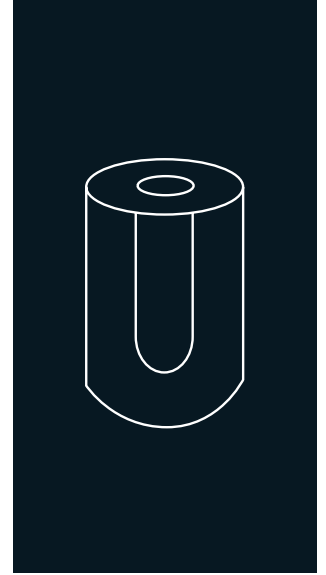

230 V / 50 Hz

### SELF-CONTAINED ICE CUBE MACHINE

#### FEATURES CARATTERISTICHE

- ▶ **PADDLE SYSTEM TO PRODUCE ICE IN THE MOST ADVERSE CONDITIONS OF WATER QUALITY (HARDWATER) AND IN THE LEAST ADEQUATE SITES.**  
SISTEMA A PALETTE CHE CONSENTE DI PRODURRE GHIACCIO IN CONDIZIONI DI QUALITÀ DELL'ACQUA AVVERSE (ACQUA DURA) E IN POSIZIONAMENTI INADEGUATI.
- ▶ **PADDLE SYSTEM THAT MAKES WATER FILTERS UNNECESSARY, AVOIDING THEIR COSTS.**  
SISTEMA A PALETTE CHE RENDE SUPERFLUI I FILTRI DELL'ACQUA.
- ▶ **WATER MOVEMENT THANKS TO PADDLES GRANTS THAT THE PUREST WATER TOUCHES THE EVAPORATOR AND GET FROZEN, OBTAINING THE CLEAREST ICE CUBE.**  
GRAZIE ALLE PALETTE, IL MOVIMENTO DELL'ACQUA ASSICURA CHE L'ACQUA CHE SI CONGELA MEGLIO TOCCA L'EVAPORATORE, OTTENENDO UN CUBETTO PIÙ CRISTALLINO.
- ▶ **DESIGNED WITHOUT THERMOSTAT, AVOIDING PROBLEMS & GETTING ALL ICE IS POSSIBLE.**  
PROGETTATA SENZA TERMOSTATO, SI EVITANO PROBLEMI E SI OTTIENE IL MASSIMO DEL GHIACCIO.
- ▶ **WITHOUT TIMER. DETECTION OF END OF CYCLE AND FULL BIN ARE DETECTED THROUGH MECHANICAL DEVICES.**  
SENZA TIMER, RILEVA IL TERMINE DEL CICLO DEL GHIACCIO E IL RIEMPIMENTO DELLA VASCHETTA MEDIANTE DISPOSITIVI MECCANICI.
- ▶ **SIMPLE AND RELIABLE MANUFACTURING DESIGN.**  
DESIGN DI FABBRICAZIONE SEMPLICE E SICURO.
- ▶ **PRODUCES A SEMI-HOLLOW CUBE WITH A GREATER SURFACE THAT COOLS FASTER THE DRINK.**  
PRODUCE UN CUBETTO SEMICAVO CON FORME CARATTERISTICHE CHE GENERANO UNA SUPERFICIE DI RAFFREDDAMENTO MAGGIORE.
- ▶ **DOOR-OPENING MOVEMENT DAMPENING SYSTEM TO AVOID ACCIDENTS.**  
APERTURA DELLA PORTA VERSO L'INTERNO PER EVITARE INCIDENTI.
- ▶ **ON/OFF LIGHTED ROCKER SWITCH IN FRONT PANEL.**  
SPIA LUMINOSA DI FUNZIONAMENTO ON/OFF SUL PANNELLO FRONTALE.
- ▶ **AISI 304 STAINLESS STEEL FRAME.**  
STRUTTURA IN ACCIAIO INOSSIDABILE AISI 304.
- ▶ **TROPICALIZED MACHINES (T CLASS).**  
MACCHINE TROPICALIZZATE (CLASSE T).



	 24 H	 10°C (Kg)	 10°C (Kg)	 21°C (Kg)	 15°C (Kg)	 STOCK (Kg)	 (mm)	 (mm)	
QUASAR 50C A		61	54	25	Width 513 Depth 557 Height 811*	Width 536 Depth 580 Height 945	Average dimensions Dimensioni medie	<b>QUASAR 20gr</b> 29 (Ø) x 42 mm (H)	
QUASAR 50C W		58	53						

\* WITH LEGS 916/966 CON PIEDINI 916/966

#### ACCESSORIES ACCESSORI

##### INCLUDED



**WATER INLET HOSE**  
TUBO INGRESSO DELL'ACQUA



**WATER OUTLET HOSE**  
TUBO DI SCARICO



**4 HEIGHT ADJUSTABLE LEG KIT**  
KIT 4 PIEDINI ALTEZZA REGOLABILE



**WATER INLET FILTER GASKET**  
GIUNTA DEL FILTRO DI INGRESSO DELL'ACQUA



**MEDIUM SCOOP**  
PALETTA MEDIA

##### NOT INCLUDED (OPTIONAL)



**ANTI-LIMESCALE FILTER**  
FILTRO ANTICALCARE



**ANTI-LIMESCALE + ANTI-CHLORINE FILTER CS101**  
FILTRO ANTICALCARE + ANTICLORO CS101



**C4 WATER SOFTENER**  
DESCALCIFICATORE C4



**CALKLIN 50 CLEANER**  
PRODOTTO ANTICALCARE



**PARTICLE FILTER**  
FILTRO ANTIPARTICOLATO



**ANTI-CHLORINE FILTER**  
FILTRO CLORO FA

QUASAR 50C

RIGHT SIDE VIEW  
VISTA LATERALE DESTRA

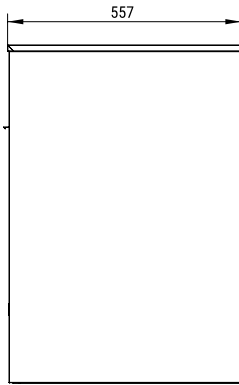

FRONTAL VIEW  
VISTA FRONTALE

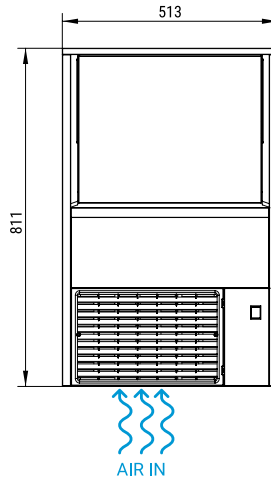

REAR VIEW  
VISTA POSTERIORE

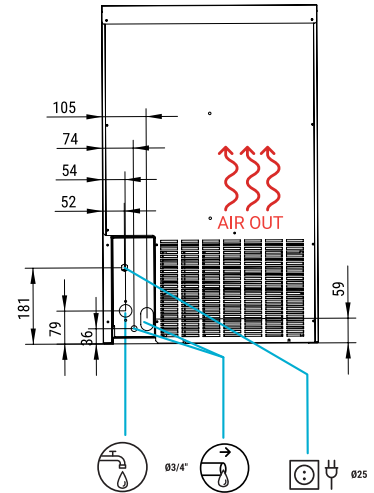

\* All measurements in mm.  
\* Tutte le misure in mm.

OPERATING CONDITIONS CONDIZIONI PER IL FUNZIONAMENTO

PRODUCTION 50Hz PRODUZIONE 50 Hz

±10% V

5°C/43°C

5°C/35°C

1 bar/6 bar

35 Ice cubes/cycle

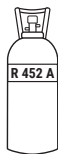

V	Hz	ph
230	50	1N

QUASAR 50C AIR COOLED

°C °F	10° 50°	15° 60°	21° 70°	30° 86°
	10°	61	56	52
21° 68°	59	54	51	46
32° 90°	52	48	45	39
43° 109°	41	36	32	27

QUASAR 50C WATER COOLED

°C °F	10° 50°	15° 60°	21° 70°	30° 86°
	10°	58	55	53
21° 68°	56	53	52	43
32° 90°	55	52	51	41
43° 109°	52	48	47	39

MODELS  
MODELLI

	ASHRAE CONDITIONS CONDICIONES ASHRAE	(W)	(BTU/h)	(W) 43°C	(n.)	(mm <sup>2</sup> )	FUSE	100 Kg (Kwh)	(l/h)	HEAT REJECTED (W)	(BTU/h)	(Kg)	(Kg)	(m <sup>3</sup> )
QUASAR 50C A		1.089	3.716	402	2	1,5	10	13	6,3	787	2.685	48	58	0,29
QUASAR 50C W		1.089	3.716	330	2	1,5	10	14	29,7	787	2.685	48	58	0,29



ITV ICE MAKERS, S.L.  
POL. IND. SECTOR 13, AVDA. DELS HOSTALERS, 2  
46394 RIBARROJA DE TURIA, VALENCIA, SPAIN  
PHONE: +34 96 166 75 75 | FAX: +34 96 166 81 00  
info@itv.es | www.itv.es



SERVICE  
SERVIZIO ASSISTENZA TECNICA  
service@itv.es  
Skype: ITV.Service  
+34 961 667 639  
8:00AM | 7:00PM



Subject to certain limitations  
and exclusions. Only spare parts.  
Soggetta a limitazioni e revoca. Solo  
parti di ricambio.



9000  
9001  
14000

