

## QUASAR 50C









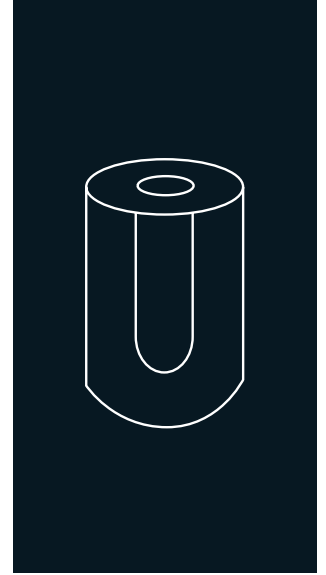

230 V / 50 Hz

### MACHINE À GLAÇONS INDÉPENDANTE

#### FEATURES CARACTÉRISTIQUES

- ▶ **PADDLE SYSTEM TO PRODUCE ICE IN THE MOST ADVERSE CONDITIONS OF WATER QUALITY (HARDWATER) AND IN THE LEAST ADEQUATE SITES.**  
UN SYSTÈME DE PALETTES QUI PERMET DE PRODUIRE DE LA GLACE DANS LES CONDITIONS DE QUALITÉ D'EAU LES PLUS DÉFAVORABLES (EAU DURE) ET DANS LES ENDROITS LES PLUS INADAPTÉS.
- ▶ **PADDLE SYSTEM THAT MAKES WATER FILTERS UNNECESSARY, AVOIDING THEIR COSTS.**  
LE SYSTÈME À PALETTES REND LES FILTRES À EAU SUPERFLUS, ÉVITANT AINSI LEURS COÛTS.
- ▶ **WATER MOVEMENT THANKS TO PADDLES GRANTS THAT THE PUREST WATER TOUCHES THE EVAPORATOR AND GET FROZEN, OBTAINING THE CLEAREST ICE CUBE.**  
LE MOUVEMENT DE L'EAU GRÂCE AUX PALETTES GARANTIT QUE L'EAU LA PLUS PURE ENTRE EN CONTACT AVEC L'ÉVAPORATEUR, CE QUI PERMET D'OBTENIR UN GLAÇON PLUS CLAIR.
- ▶ **DESIGNED WITHOUT THERMOSTAT, AVOIDING PROBLEMS & GETTING ALL ICE IS POSSIBLE.**  
CONÇU SANS THERMOSTAT, POUR ÉVITER LES PROBLÈMES ET OBTENIR LE PLUS DE GLACE POSSIBLE.
- ▶ **WITHOUT TIMER. DETECTION OF END OF CYCLE AND FULL BIN ARE DETECTED THROUGH MECHANICAL DEVICES.**  
SANS MINUTERIE, LA FIN DU CYCLE DE LA GLACE ET LE REMPLISSAGE DU MAGASIN SONT DÉTECTÉS PAR DES DISPOSITIFS MÉCANIQUES. DISPOSITIFS MÉCANIQUES.
- ▶ **SIMPLE AND RELIABLE MANUFACTURING DESIGN.**  
UNE CONCEPTION DE FABRICATION SIMPLE ET FIABLE.
- ▶ **PRODUCES A SEMI-HOLLOW CUBE WITH A GREATER SURFACE THAT COOLS FASTER THE DRINK.**  
PRODUCTION D'UN GLAÇON SEMI-CREUX AVEC UNE PLUS GRANDE SURFACE QUI REFRROIDIT LA BOISSON PLUS RAPIDEMENT.
- ▶ **DOOR-OPENING MOVEMENT DAMPENING SYSTEM TO AVOID ACCIDENTS.**  
OUVERTURE DE PORTE VERS L'INTÉRIEUR AFIN D'ÉVITER LES ACCIDENTS.
- ▶ **ON/OFF LIGHTED ROCKER SWITCH IN FRONT PANEL.**  
INTERRUPTEUR LUMINEUX DE FONCTIONNEMENT ON/OFF DANS LE PANNEAU AVANT.
- ▶ **AISI 304 STAINLESS STEEL FRAME.**  
CARROSSERIE EN ACIER INOXYDABLE AISI 304.
- ▶ **TROPICALIZED MACHINES (T CLASS).**  
MACHINES TROPICALISÉES (CLASSE T).



	 24 H	 10°C (Kg)	 10°C (Kg)	 21°C (Kg)	 15°C (Kg)	 STOCK (Kg)	 (mm)	 (mm)	
QUASAR 50C A		61	48	15	Width 513	Width 536	<b>QUASAR 20gr</b> 29 (Ø) x 42 mm (H) Average dimensions Dimensions moyennes		
QUASAR 50C W		58	51		Depth 557	Depth 580			
					Height 811*	Height 945			

\* WITH LEGS 916/966 AVEC PIEDS 916/966

#### ACCESSORIES ACCESSOIRES

##### INCLUDED



WATER INLET HOSE  
TUYAU D'ENTRÉE D'EAU



WATER OUTLET HOSE  
TUYAU D'ÉVACUATION



4 HEIGHT ADJUSTABLE LEG KIT  
KIT 4 PIEDS RÉGLABLE EN HAUTEUR



WATER INLET FILTER GASKET  
JOINT DE FILTRE D'ENTRÉE D'EAU



MEDIUM SCOOP  
PALE MOYENNE

##### NOT INCLUDED (OPTIONAL)



ANTI-LIMESCALE FILTER  
FILTRE ANTICALCAIRE



C4 WATER SOFTENER  
ADOUCCISSEUR C4



ANTI-LIMESCALE + ANTI-CHLORINE FILTER CS101  
FILTRE ANTICALCAIRE + ANTI-CHLORE CS101



CALKLIN 50 CLEANER  
PRODUIT ANTICALCAIRE



PARTICLE FILTER  
FILTRE ANTIPARTICULES



ANTI-CHLORINE FILTER  
FILTRE ANTI-CHLORE

QUASAR 50C

RIGHT SIDE VIEW  
VUE LATÉRALE DROITE

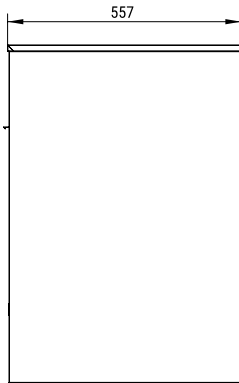

FRONTAL VIEW  
VUE DE FACE

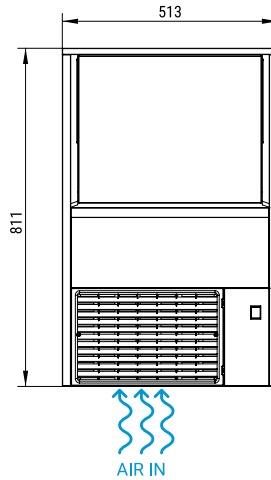

REAR VIEW  
VUE ARRIÈRE

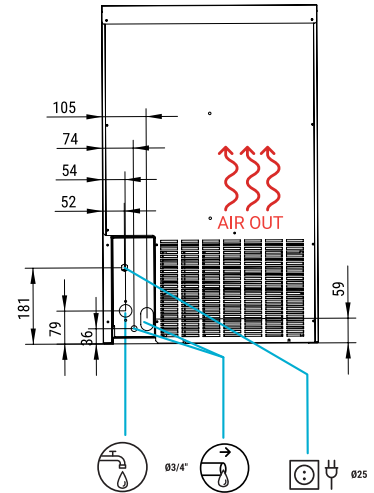

\*All measurements in mm.  
\*Toutes les cotes sont en mm.

OPERATING CONDITIONS CONDITIONS DE FONCTIONNEMENT

PRODUCTION 50Hz PRODUCTION 50 Hz

±10% V

5°C/43°C

5°C/35°C

1 bar/6 bar

35 Ice cubes/cycle

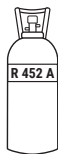

V	Hz	ph
230	50	1N

QUASAR 50C AIR COOLED

°C °F	10° 50°	15° 60°	21° 70°	30° 86°
	10°	61	56	52
21° 68°	59	48	51	46
32° 90°	52	48	45	39
43° 109°	41	36	32	27

QUASAR 50C WATER COOLED

°C °F	10° 50°	15° 60°	21° 70°	30° 86°
	10°	58	55	53
21° 68°	56	51	52	43
32° 90°	55	52	51	41
43° 109°	52	48	47	39

MODÈLES

QUASAR 50C A

QUASAR 50C W

	ASHRAE CONDITIONS CONDICIONES ASHRAE	(W)	(BTU/h)	(W) 43°C	(n.)	(mm <sup>2</sup> )	FUSE	100 Kg (Kwh)	(l/h)	HEAT REJECTED (W)	(BTU/h)	(Kg)	(Kg)	(m <sup>3</sup> )
QUASAR 50C A		1.089	3.716	401	2	1,5	10	13	6,3	787	2.685	48	58	0,29
QUASAR 50C W		1.089	3.716	401	2	1,5	10	14	29,7	787	2.685	48	58	0,29



ITV ICE MAKERS, S.L.  
POL. IND. SECTOR 13, AVDA. DELS HOSTALERS, 2  
46394 RIBARROJA DE TURIA, VALENCIA, SPAIN  
PHONE: +34 96 166 75 75 | FAX: +34 96 166 81 00  
info@itv.es | www.itv.es



TECHNICAL ASSISTANCE  
SERVICE D'ASSISTANCE TECHNIQUE  
service@itv.es  
Skype: ITV.Service  
+34 961 667 639  
8:00AM | 7:00PM



Subject to certain limitations  
and exclusions. Only spare parts.  
Sujet à limitations et exclusions.  
Pièces de rechange uniquement.

