

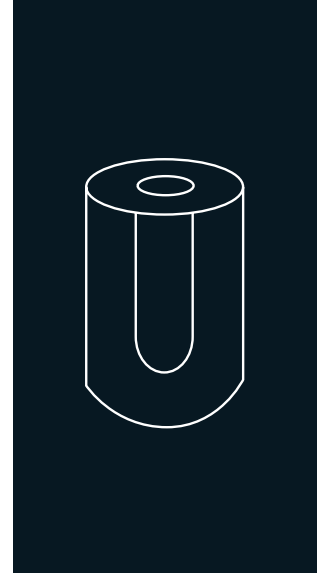











QUASAR 20C 230 V / 50 Hz

MACHINE À GLAÇONS INDÉPENDANTE

FEATURES CARACTÉRISTIQUES

- ▶ **PADDLE SYSTEM TO PRODUCE ICE IN THE MOST ADVERSE CONDITIONS OF WATER QUALITY (HARDWATER) AND IN THE LEAST ADEQUATE SITES.**
UN SYSTÈME DE PALETTES QUI PERMET DE PRODUIRE DE LA GLACE DANS LES CONDITIONS DE QUALITÉ D'EAU LES PLUS DÉFAVORABLES (EAU DURE) ET DANS LES ENDROITS LES PLUS INADAPTÉS.
- ▶ **PADDLE SYSTEM THAT MAKES WATER FILTERS UNNECESSARY, AVOIDING THEIR COSTS.**
LE SYSTÈME À PALETTES REND LES FILTRES À EAU SUPERFLUS, ÉVITANT AINSI LEURS COÛTS.
- ▶ **WATER MOVEMENT THANKS TO PADDLES GRANTS THAT THE PUREST WATER TOUCHES THE EVAPORATOR AND GET FROZEN, OBTAINING THE CLEAREST ICE CUBE.**
LE MOUVEMENT DE L'EAU GRÂCE AUX PALETTES GARANTIT QUE L'EAU LA PLUS PURE ENTRE EN CONTACT AVEC L'ÉVAPORATEUR, CE QUI PERMET D'OBTENIR UN GLAÇON PLUS CLAIR.
- ▶ **DESIGNED WITHOUT THERMOSTAT, AVOIDING PROBLEMS & GETTING ALL ICE IS POSSIBLE.**
CONÇU SANS THERMOSTAT, POUR ÉVITER LES PROBLÈMES ET OBTENIR LE PLUS DE GLACE POSSIBLE.
- ▶ **WITHOUT TIMER. DETECTION OF END OF CYCLE AND FULL BIN ARE DETECTED THROUGH MECHANICAL DEVICES.**
SANS MINUTERIE, LA FIN DU CYCLE DE LA GLACE ET LE REMPLISSAGE DU MAGASIN SONT DÉTECTÉS PAR DES DISPOSITIFS MÉCANIQUES. DISPOSITIFS MÉCANIQUES.
- ▶ **SIMPLE AND RELIABLE MANUFACTURING DESIGN.**
UNE CONCEPTION DE FABRICATION SIMPLE ET FIABLE.
- ▶ **PRODUCES A SEMI-HOLLOW CUBE WITH A GREATER SURFACE THAT COOLS FASTER THE DRINK.**
PRODUCTION D'UN GLAÇON SEMI-CREUX AVEC UNE PLUS GRANDE SURFACE QUI REFROIDIT LA BOISSON PLUS RAPIDEMENT.
- ▶ **DOOR-OPENING MOVEMENT DAMPENING SYSTEM TO AVOID ACCIDENTS.**
OUVERTURE DE PORTE VERS L'INTÉRIEUR AFIN D'ÉVITER LES ACCIDENTS.
- ▶ **ON/OFF LIGHTED ROCKER SWITCH IN FRONT PANEL.**
INTERRUPTEUR LUMINEUX DE FONCTIONNEMENT ON/OFF DANS LE PANNEAU AVANT.
- ▶ **AISI 304 STAINLESS STEEL FRAME.**
CARROSSERIE EN ACIER INOXYDABLE AISI 304.
- ▶ **TROPICALIZED MACHINES (T CLASS).**
MACHINES TROPICALISÉES (CLASSE T).



	 24 H	 10°C (Kg)	 10°C (Kg)	 21°C (Kg)	 15°C (Kg)	 STOCK (Kg)	 (mm)	 (mm)	
QUASAR 20C A		24	22	6	6	Width 401	Width 495	QUASAR 20gr 29 (Ø) x 42 mm (H) Average dimensions Dimensions moyennes	
QUASAR 20C W		27	24			Depth 506	Depth 605		
						Height 643*	Height 760		

* WITH LEGS 700 AVEC PIEDS 700

ACCESSORIES ACCESSOIRES

INCLUDED



WATER INLET HOSE
TUYAU D'ENTRÉE D'EAU



WATER OUTLET HOSE
TUYAU D'ÉVACUATION



4 LEG KIT
KIT 4 PATAS



WATER INLET FILTER GASKET
JOINT DE FILTRE D'ENTRÉE D'EAU



MEDIUM SCOOP
PALE MOYENNE

NOT INCLUDED (OPTIONAL)



ANTI-LIMESCALE FILTER
FILTRE ANTICALCAIRE



ANTI-LIMESCALE + ANTI-CHLORINE FILTER CS101
FILTRE ANTICALCAIRE + ANTI-CHLORE CS101



C4 WATER SOFTENER
ADOUCCISSEUR C4



CALKLIN 50 CLEANER
PRODUIT ANTICALCAIRE



PARTICLE FILTER
FILTRE ANTIPARTICULES



ANTI-CHLORINE FILTER
FILTRE ANTI-CHLORE

QUASAR 20C

RIGHT SIDE VIEW
VUE LATÉRALE DROITE



FRONTAL VIEW
VUE DE FACE

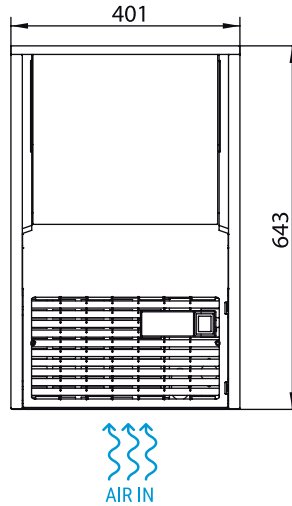

REAR VIEW
VUE ARRIÈRE

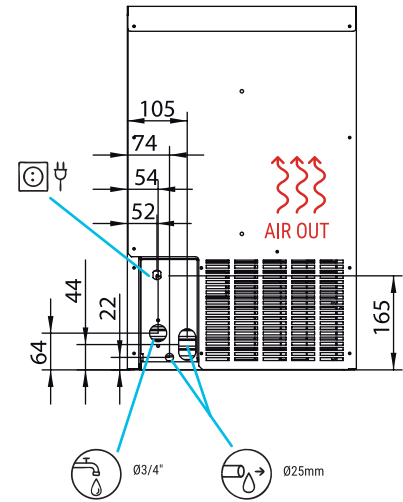

*All measurements in mm.
*Toutes les cotes sont en mm.

OPERATING CONDITIONS CONDITIONS DE FONCTIONNEMENT

PRODUCTION 50Hz PRODUCTION 50 Hz

±10% V

5°C/43°C

5°C/35°C

1 bar/6 bar

15 Ice cubes/cycle

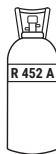

V	Hz	ph
230	50	1N

QUASAR 20C AIR COOLED

°C °F	10° 50°	15° 60°	21° 70°	30° 86°
	10°	24	23	22
21° 68°	23	22	20	19
32° 90°	19	18	15	14
43° 109°	14	12	9	7

QUASAR 20C WATER COOLED

°C °F	10° 50°	15° 60°	21° 70°	30° 86°
	10°	27	25	23
21° 68°	26	24	22	20
32° 90°	25	23	21	19
43° 109°	24	22	21	19

MODÈLES

QUASAR 20C A

QUASAR 20C W

	ASHRAE CONDITIONS CONDICIONES ASHRAE	ASHRAE 43°C	(n.)	(mm ²)	FUSE	100 Kg	(l/h)	HEAT REJECTED	(Kg)	(Kg)	(m ³)
	(W) (BTU/h)	(W) 43°C	(n.)	(mm ²)	FUSE	100 Kg	(l/h)	(W) (BTU/h)	(Kg)	(Kg)	(m ³)
QUASAR 20C A	758 2.586	287	3	1,5	10	22,8	4,2	530 1.808	36	40	0,23
QUASAR 20C W	758 2.586	189	3	1,5	10	18	16,9	530 1.808	36	40	0,23



ITV ICE MAKERS, S.L.
POL. IND. SECTOR 13, AVDA. DELS HOSTALERS, 2
46394 RIBARROJA DE TURIA, VALENCIA, SPAIN
PHONE: +34 96 166 75 75 | FAX: +34 96 166 81 00
info@itv.es | www.itv.es



TECHNICAL ASSISTANCE
SERVICE D'ASSISTANCE TECHNIQUE
service@itv.es
Skype: ITV.Service
+34 961 667 639
8:00AM | 7:00PM



Subject to certain limitations and exclusions. Only spare parts.
Sujet à limitations et exclusions.
Pièces de rechange uniquement.

