

KITCHEN ICE

230 V / 50 Hz

DOMESTIC ICE MACHINE

FEATURES CARATTERISTICHE



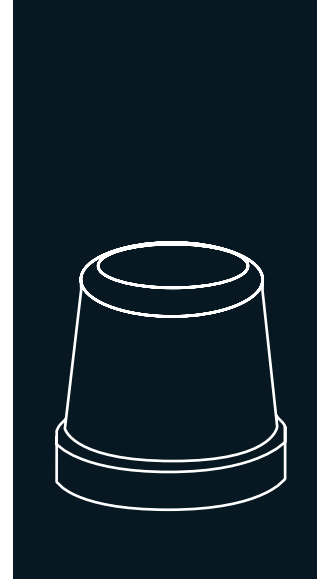





- ▶ **PRODUCES PROFESSIONAL 22 GRS GOURMET CRYSTAL ICE CUBES**
PRODUCE CUBETTI PROFESSIONALI DI GHIACCIO GOURMET CRISTALLINO DI 22 GR
- ▶ **DESIGNED FOR HOME APPLICATIONS**
PROGETTATO PER APPLICAZIONI DOMESTICHE
- ▶ **AISI 304 STAINLESS STEEL BODYWORK**
TELAIO IN ACCIAIO INOSSIDABILE AISI 304
- ▶ **DAILY ICE PRODUCTION 13 KG**
PRODUZIONE GIORNALIERA DI GHIACCIO: 13 KG
- ▶ **12 ICE CUBES EVERY 38 MINUTES (NOMINAL CONDITIONS)**
12 CUBETTI DI GHIACCIO OGNI 38 MINUTI (IN CONDIZIONI NOMINALI)
- ▶ **8 KG STOCK INSIDE**
STOCCAGGIO DI 8 KG
- ▶ **DINAMIC ICE PRODUCTION: ICE MORE TRANSPARENT, NO SMELL & NO TASTE**
PRODUZIONE DI GHIACCIO DINAMICA: GHIACCIO PIÙ TRASPARENTE, SENZA ODORE E GUSTO
- ▶ **REDUCE CALCIUM CARBONATE PERCENTAGE**
RIDUCE LA PERCENTUALE DI CARBONATO DI CALCIO
- ▶ **DIMENSIONS TO BE BUILT IN STANDARD KITCHEN 60 CM WIDTH FURNITURE**
DIMENSIONI PER MOBILI DA CUCINA STANDARD DI 60 CM
- ▶ **EASY FRONT & BACK VENTILATION**
DI FACILE UTILIZZO E CON VENTILAZIONE POSTERIORE
- ▶ **A3S: ANTI-SCALE SPRAY SYSTEM. ITV PATENTED SPRAY SYSTEM WITH FLEXIBLE NOZZLES THAT AVOID LIMESCALE DEPOSITS WITH SMALL VIBRATIONS**
A3S: ANTI-SCALE SPRAY SYSTEM. SISTEMA DI NEBULIZZAZIONE CON UGELLO FLESSIBILE BREVETTATO DA ITV CHE EVITA PICCOLI DEPOSITI DI CALCARE TRAMITE VIBRAZIONE
- ▶ **ON/OFF PROGRAMABLE**
ORA DI ACCENSIONE E SPEGNIMENTO PROGRAMMABILE



A3S
Anti-scale
spray
system

SILENT
RAIN

FRONT
VENTILATION

KITCHEN ICE	 24 H (Kg)	 10°C (Kg)	 10°C (Kg)	 21°C (Kg)	 15°C (Kg)	 STOCK (Kg)	 (mm)	 (mm)	
	15	13	8	458	575	595	588	680	680

GALA 22gr

35 (Ø) x 35 mm (H)

*Average dimensions Dimensioni medie

ACCESSORIES ACCESSORI

INCLUDED



WATER INLET HOSE
TUBO INGRESSO
DELL'ACQUA



WATER OUTLET HOSE
TUBO USCITA
DELL'ACQUA



WATER INLET FILTER GASKET
GIUNTA DEL FILTRO DI
INGRESSO DELL'ACQUA



SMALL SCOOP
PALETTA PICOLA

OPTIONAL (NOT INCLUDED)



ANTI-LIMESCALE FILTER
FILTRO ANTICALCARE



PARTICLE FILTER
FILTRO
ANTIPARTICOLATO



ANTI-CHLORINE FILTER
FILTRO ANTICLORO



**ANTI-LIMESCALE +
ANTI-CHLORINE FILTER CS101**
FILTRO ANTICALCARE +
ANTICLORO CS101

KITCHEN ICE

REAR VIEW
VISTA POSTERIORE

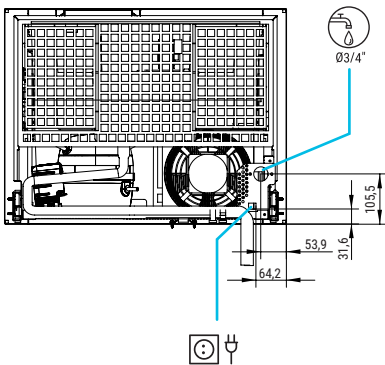

RIGHT SIDE VIEW
VISTA LATERALE DESTRA

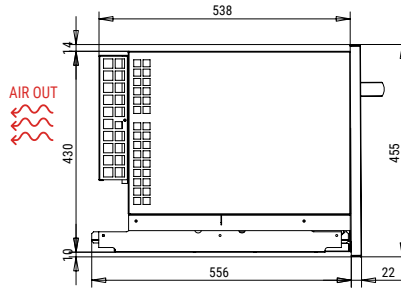

FRONTAL VIEW
VISTA FRONTALE

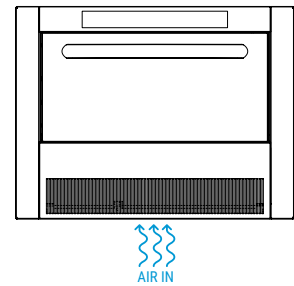

FLOOR VIEW
VISTA IN PIANTA

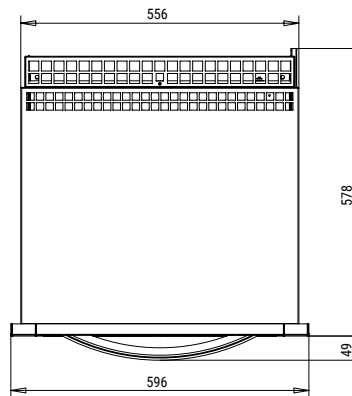

* All measurements in mm.
* Tutte le misure in mm.

OPERATING CONDITIONS CONDIZIONI PER IL FUNZIONAMENTO

PRODUCTION 50Hz PRODUZIONE 50 Hz

±10% V

5°C/43°C

5°C/35°C

1 bar/6 bar

12 Ice cubes/cycle

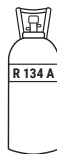

V	Hz	ph
230	50	1N

KITCHEN ICE AIR COOLED

	10°	15°	21°	30°
	50°	60°	70°	86°
10°	15	14	13	11
50°	14	13	12	10
21°	11	10	10	9
68°	9	8	8	8
32°				
90°				
43°				
109°				

MODELS
MODELLI

KITCHEN ICE

	ASHRAE CONDITIONS CONDICIONES ASHRAE (W) (BTu/h)	(W) 43°C	(n.) (mm ²)	FUSE	100 Kg (Kwh)	(l/h)	HEAT REJECTED (W) (BTu/h)	(Kg)	(Kg)	(m ³)
KITCHEN ICE	418 1.426	203	3 1,5	10	32	1,8	300 1.024	40	46	0,27



ITV ICE MAKERS, S.L.
POL. IND. SECTOR 13, AVDA. DELS HOSTALERS, 2
46394 RIBARROJA DE TURIA, VALENCIA, SPAIN
PHONE: +34 96 166 75 75 | FAX: +34 96 166 81 00
info@itv.es | www.itv.es



SERVICE
SERVIZIO ASSISTENZA TECNICA
service@itv.es
Skype: ITV.Service
+34 961 667 639
8:00AM | 7:00PM



Subject to certain limitations
and exclusions. Only spare parts.
Soggetta a limitazioni e revoca. Solo
parti di ricambio.

