

# KITCHEN ICE

230 V / 50 Hz

## GOURMETEIS ZU HAUSE

### EIGENSCHAFTEN



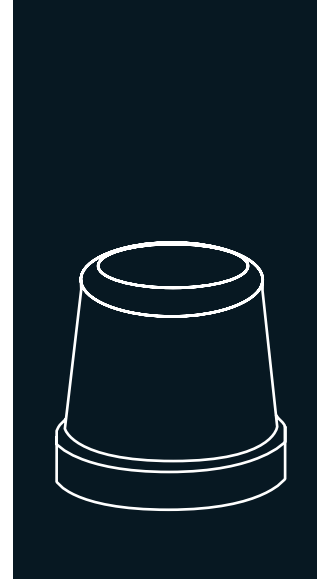







- ▶ PRODUZIERT PROFESSIONELLE KRISTALLKLARE 22G EISKEGEL
- ▶ ENTWICKELT FÜR DIE ANWENDUNG ZUHAUSE
- ▶ KÖRPER AUS EDELSTAHL AISI 304
- ▶ TAGESPRODUKTION 13 KG
- ▶ 12 EISKEGEL ALLE 38 MINUTEN (NOMINALE BEDINGUNGEN)
- ▶ 8 KG VORRATSBEHÄLTER
- ▶ DYNAMISCHE EISPRODUKTION: TRANSPARENTES EIS OHNE GERUCH & OHNE GESCHMACK
- ▶ ABMESSUNGEN FÜR STANDARDKÜCHE: 60 CM BREITE MÖBEL
- ▶ FRONTALE BELÜFTUNG
- ▶ A3S: ANTI-KALK SPRAY-SYSTEM. DAS ITV-PATENTIERTE SPRÜHSYSTEM MIT FLEXIBELN DÜSEN, VERMEIDET KALKANSAMMLUNGEN MIT KLEINEN VIBRATIONEN
- ▶ PROGRAMMIERBARE EIN- UND AUSSCHALTZEIT



SILENT RAIN



FRONT VENTILATION

	 24 H	 10°C	 10°C	 21°C	 15°C	 STOCK			
		(Kg)	(Kg)	(Kg)	(Kg)	(mm)	(mm)		
KITCHEN ICE		15	13	8	Breite 458 Tiefe 575 Höhe 595	Breite 588 Tiefe 680 Höhe 680	<b>GALA 22gr</b> 35 (Ø) x 35 mm (H) *DURCHSCHNITTSGRÖÙE		

### ZUBEHÖR

#### EINBEGRIFFEN



#### EMPFOHLEN



# TECHNISCHE DATEN

## KITCHEN ICE

RÜCKANSICHT

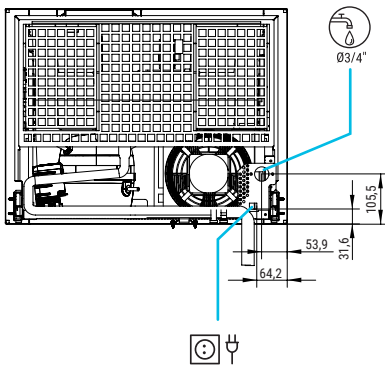

RECHTE SEITENANSICHT

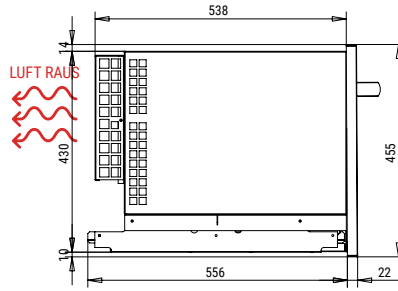

FRONTANSICHT

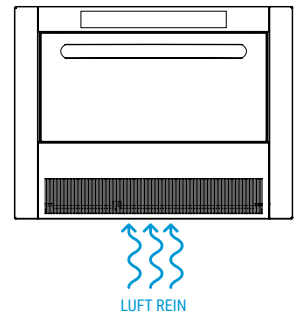

UNTERE ANSICHT

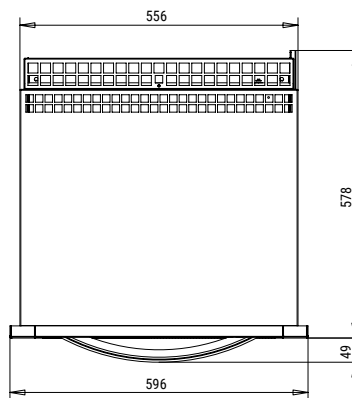

\* Alle Größen in mm.

## LEISTUNGEN

### PRODUKTION 50Hz

±10% V

5°C/43°C

5°C/35°C

1 bar/6 bar

12 Eiskegel/Zyklus

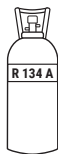

V	Hz	ph
230	50	1N



KITCHEN ICE LUFTGEKÜHLT

	10°	15°	21°	30°
	50°	60°	70°	86°
10°	15	14	13	11
50°				
21°	14	13	12	10
68°				
32°	11	10	10	9
90°				
43°	9	8	8	8
109°				

### MODEL

	+c° -c°	ASHRAE KONDITIONIEN (W) (BTu/h)	(W) 43°C	(n.) (mm²)	SICHERUNG	100 Kg (Kwh)	(l/h)	(W) (BTu/h)	(Kg)	(Kg)	(m³)
KITCHEN ICE		418 1.426	203	3 1,5	10	32	1,8	300 1.024	40	46	0,27



ITV ICE MARKES, S.L.  
POL. IND. SECTOR 13, AVDA. DELS HOSTALERS, 2  
46394 RIBARROJA DE TURIA, VALENCIA, SPAIN  
PHONE: +34 96 166 75 75 | FAX: +34 96 166 81 00  
info@itv.es | www.itv.es



SERVICE  
service@itv.es  
Skype: ITV.Service  
+34 961 667 639  
8:00AM | 7:00PM



Auf Teile und Lohn.  
Vorbehaltlich bestimmter  
Einschränkungen und  
Ausschlüsse.



SPRÜHSYSTEM  
HORIZONTALER VERDAMPFER