

TYPE DE GLAÇON

UTILISATION ET APPLICATIONS



TYPE DE GLAÇON

GLAÇON GOURMET



Alfa Mini



Gala



Pulsar



Delta Max



Super Star



Super Star Plus

CARACTÉRISTIQUES

- Glaçon pure, transparent, cristallin, sans trous ni arêtes.
- Parfait pour être servi avec des boissons ou des cocktails.
- Il tourne dans le verre et refroidit sans se convertir en eau.
- ITV fabrique cette glace en 6 tailles.



GLAÇON CREUX



Quasar

CARACTÉRISTIQUES

- Glaçon facile à manipuler, très polyvalent.
- Machine très fiable.
- Capable d'être produit dans les conditions les plus défavorables de qualité et de température de l'eau.
- Il fond rapidement.



DÉS ET DEMI-DÉS



Spika Dés



Spika Demi-Dés

CARACTÉRISTIQUES

- Un glaçon idéal pour la restauration rapide et la grande consommation.
- Il refroidit rapidement.
- Les glaçons peuvent être distribués automatiquement.
- Idéal pour les boissons rafraîchissantes.
- ITV fabrique ce glaçon en deux formats (dés et demi-dés).



GLAÇON NUGGET



Nugget

CARACTÉRISTIQUES

- Une glace parfaite pour les boissons mélangées. Mélange délicatement les saveurs sans édulcorer la boisson.
- Également utilisé pour refroidir les jus de fruits ou les yaourts dans les présentoirs alimentaires.
- Teneur en eau de 10%.
- Texture compacte, à mi-chemin entre le glaçon et la glace pilée, uniformément écrasée.
- Une glace croquante qui ne nuit pas à la saveur de la boisson.



GLAÇON GRANULAIRE OU PILÉE



Diamond

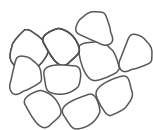

Chip



Granular

CARACTÉRISTIQUES

- Une glace parfaite pour les poissonneries, les expositions alimentaires, le secteur de la santé et l'industrie.
- Elle refroidit rapidement.
- Température de 0°C à -1°C
- 1,6 M³ équivaut à 1 MT de glace.
- ITV fabrique cette glace sous trois formats (Diamant, granulaire et chip).



GLAÇON EN ÉCAILLE



Scala

CARACTÉRISTIQUES

- Une glace parfaite pour l'industrie alimentaire, la construction et le transport.
- Écaille plate très froide et sèche.
- 2 % d'humidité.
- Température -7°C
- 2M³ équivaut à 1 MT de glace.



TYPE DE GLAÇON

GLAÇONS



Pulsar

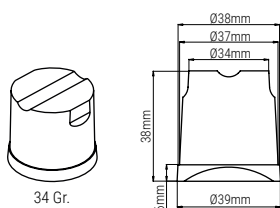

PRODUCTION KG/LB
De 25/50 à 145/300



Quasar

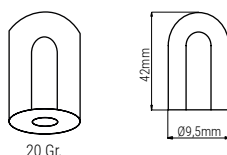

PRODUCTION KG/LB
De 20/35 à 190/420



Spika FD/HD

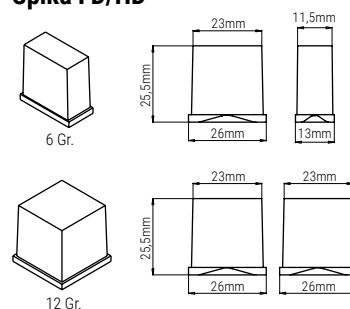

PRODUCTION KG/LB
De 60/115 à 400/880



Mini Alfa

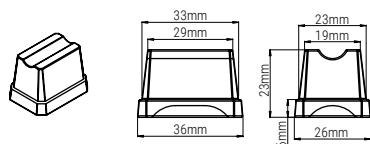

PRODUCTION KG/LB
De 20/35 à 400/883

Gala

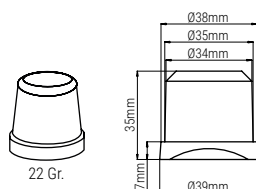

Delta Max

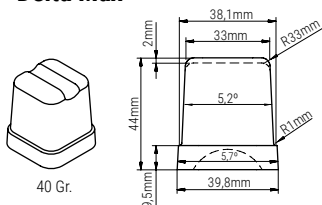

Super Star +

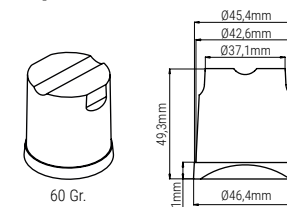

Super Star

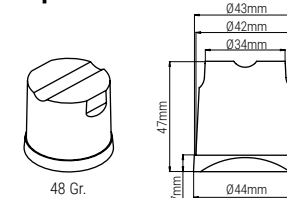

GLAÇON NUGGET

Nugget



GLAÇON NUGGET

PRODUCTION KG/LB
De 300/661 à 500/1102

GLAÇON GRANULAIRE

Ice Queen



GLAÇON DIAMOND

GLAÇON GRANULAIRE

GLAÇON CHIP

PRODUCTION KG/LB
De 50/85 à 1100/2425

GLAÇON EN ÉCAILLE

























Scala





















GLAÇON EN ÉCAILLE

PRODUCTION KG/LB
De 400/750 à 50T/110K

UTILISATIONS DE LA GLACE

	TYPE DE GLACE	QUANTITÉ	GAM
Bar traditionnel	 	0,1 Kg / client	Alfa / Quasar
Cafétéria	 	0,04 Kg / client	Gala / Quasar
Pub, Club		0,25 Kg / client	Delta Max / Pulsar
Night Club		0,3 Kg / client	Delta Max / Super Star Plus
Discothèques		0,3 Kg / client	Super Star Plus
Boissons Premium		2 pièces de glace / verre	Gala / Delta / Pulsar
Cocktails	 	3 pièces de glace / verre	Super Star Plus / Nugget
Boissons rafraîchissantes		3 pièces de glace / verre	Alfa / Gala / Delta Max / Pulsar
Fast Food		0,07 Kg / Verre SMALL	Spika
		0,11 Kg / Verre MEDIUM	Spika
		0,15 Kg / Verre LARGE	Spika
Restaurant standard	 	0,15 Kg / Client	Alfa / Gala / Delta Max / Pulsar / Quasar
Restaurant	 	0,3 Kg / Client	Alfa / Gala / Delta Max / Pulsar / Quasar
Restaurant de fruits de mer	 	0,5 Kg / Client	Alfa / Gala / Delta Max / Pulsar / Quasar
		1,25 Kg / Client	Ice Queen
Hôtel		0,3 Kg / Chambre	Alfa / Gala / Delta Max / Pulsar
Camping		0,3 Kg / Place	Alfa / Gala / Quasar
		0,8 Kg / Place	Ice Queen
Maison de retraite		0,2 Kg / Chambre	Alfa / Gala / Quasar

-  GLAÇON SOLIDE
-  DÉ/DEMI-DÉ
-  GLAÇON CREUX
-  HIELO NUGGET
-  GLAÇON GRANULAIRE
-  GLACE EN ÉCAILLE

	TYPE DE GLACE	QUANTITÉ	GAM
Exposition boisson/aliments	  	1 Kg / Seau à glace simple	Ice Queen / Quasar / Nugget
	  	6 Kg / Seau de glace	Ice Queen / Quasar / Nugget
Plateau de fruits de mer	 	1,3 Kg / Plateau SMALL	Ice Queen / Scala
	 	3 Kg / Plateau MEDIUM	Ice Queen / Scala
	 	6 Kg / Plateau LARGE	Ice Queen / Scala
Buffet sur glace 10 cm.		70 Kg / m ²	Ice Queen
		12 Kg / Plateau gastronomique 1/1	Ice Queen
Étalage de poissonnerie		1m ² 10 cm 100 Kg	Ice Queen
		1m ² 10 cm 85 Kg	Scala
Poissonnerie Stockage/chamb		0,30 Kg / 1 Kg Poisson	Ice Queen
Hôpital		0,30 Kg / Patient	Alfa / Gala
Laboratoire		1 Kg / Cuvette	Ice Queen
		5 Kg / Réfrigérateur	Ice Queen
Physiothérapie		0,80 Kg / Patient	Ice Queen
Récupération RICE		0,5 Kg / Application	Ice Queen
Douche froide - SPA		150 Kg / Douche	Ice Queen
Thérapie au laser		0,30 Kg / Patient	Ice Queen
Industrie de la pêche	 	Chambre 0,30 Kg / 1 Kg poisson	Ice Queen / Scala
	 	Embarqué zone tropicale 0,5 Kg / 1 Kg poisson	Ice Queen / Scala
	 	Embarqué zone tropicale 1 Kg / 1 Kg poisson	Ice Queen / Scala
Industrie de la viande	 	0,25 Kg / 1 Kg	Ice Queen / Scala
Industrie de la boulangerie	 	0,20 Kg / 1 Kg	Ice Queen / Scala
Colorations	 	0,50 Kg / 1 m ²	Ice Queen / Scala
Béton		50 Kg / 1 m ³	Scala

	GLAÇON SOLIDE
	DÉ/DEMI-DÉ
	GLAÇON CREUX
	HIELO NUGGET
	GLAÇON GRANULAIRE
	GLACE EN ÉCAILLE

APPLICATIONS

HOSTELLERIE & QSR



APPLICATIONS

INDUSTRIE



APPLICATIONS

RETAIL



SANTÉ





C/00000_06/JJ21
ITV ICE MAKERS, S.L.
POL. IND. SECTOR 13, AVDA. DELS HOSTALERS, 2 46394
RIBARROJA DE TURIA, VALENCIA, SPAIN
PHONE: +34 96 166 75 75 | FAX: +34 96 166 81 00
comercial@itv.es | www.itv.es