

TYPE OF ICE

USES & APPLICATIONS



TYPE OF ICE

GOURMET ICE



Alfa Mini



Gala



Pulsar



Delta Max



Super Star



Super Star Plus

FEATURES

- Pure, transparent, crystalline ice, without hollows or ridges.
- Perfect for drinks and cocktails.
- Spin around the cup and the ice cooled without water down.
- ITV produce this ice in 6 sizes.



HOLLOW ICE CUBE



Quasar

FEATURES

- Easy manipulation, very versatile.
- Reliable machine.
- Designed to produce ice in the most adverse conditions of water quality and temperature.
- Melt very fast.



FULL DICE & HALF DICE CUBE



Spika Dice



Spika Half Dice

FEATURES

- Perfect ice for fast-food and large consumption of ice.
- Ice that cool the drink at full speed.
- Automatically dispensable ice.
- Ideal for soft drinks.
- ITV produce this ice in 2 shapes (full and half dice).



NUGGET ICE



Nugget

FEATURES

- Perfect ice for mixed drinks. Gently mixes the flavours without watering down the drink.
- Also used to cool fruit juices or yoghurts at food displays.
- Moisture content of 10%.
- Compact texture, halfway between ice cube and crushed ice, evenly chopped.
- Crunchy ice that does not detract from the flavour of the drink.



CRUSHED ICE



Diamond

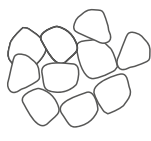

Chip



Granular

FEATURES

- Perfect ice for supermarkets, transporting fish, fruit or vegetables, food expositions, health and industry.
- Ice that cool at full speed.
- Temperature from 0°C to -1°C.
- 1,6 M³ is equal to 1 TM of ice.
- ITV produce this ice in 3 shapes (diamond, granular and chip).



FLAKE ICE



Scala

FEATURES

- Perfect ice for food industry, construction and transport.
- Flat flakes very cold and dry.
- Humidity 2%
- Temperature -7°C.
- 2M³ is equal to 1 TM of ice.



TYPE OF ICE

ICE CUBES



Pulsar

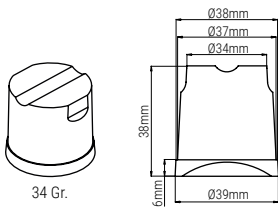

PRODUCTION KG/LB
From 25/50 to 145/300



Quasar

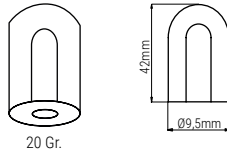

PRODUCTION KG/LB
From 20/35 to 190/420



Spika FD/HD

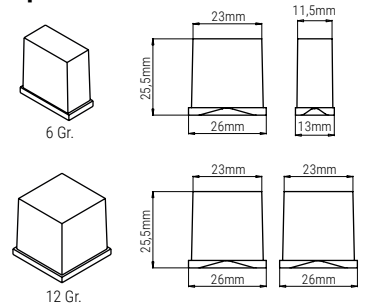

PRODUCTION KG/LB
From 60/115 to 400/880



Mini Alfa

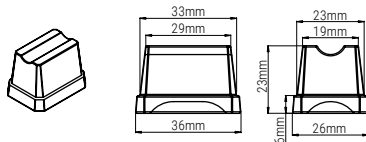

PRODUCTION KG/LB
From 20/35 to 400/883

Gala

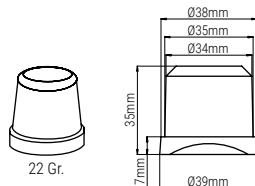

Delta Max

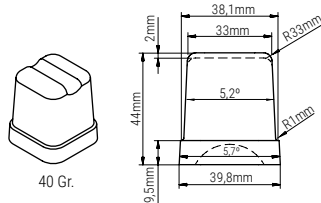

Super Star +

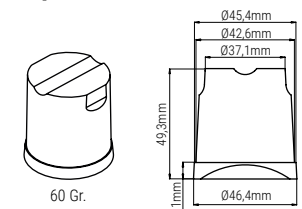

Super Star

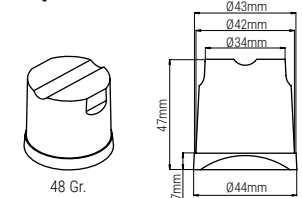

NUGGET ICE

Nugget



NUGGET ICE

PRODUCTION KG/LB
From 300/661 to 500/1102

CRUSHED ICE

IQ



DIAMOND ICE

GRANULAR ICE

CHIP ICE

PRODUCTION KG/LB
From 50/85 to 1100/2425

FLAKE ICE

























Scala



























FLAKE ICE







PRODUCTION KG/LB
From 400/750 to 50T/110K

ICE APPLICATIONS

	TYPE OF ICE	QUANTITY	RANGE
Traditional bar	 	0,1 Kg / customer	Alfa / Quasar
Café	 	0,04 Kg / customer	Gala / Quasar
Pub, Club		0,25 Kg / customer	Delta Max / Pulsar
Night Club		0,3 Kg / customer	Delta Max / Super Star Plus
Disco		0,3 Kg / customer	Super Star Plus
Premium drinks		2 ice piece / glass	Gala / Delta / Pulsar
Cocktails	 	3 ice piece / glass	Super Star Plus / Nugget
Soft drinks		3 ice piece / glass	Alfa / Gala / Delta Max / Pulsar
Fast Food		0,07 Kg / Glass SMALL	Spika
		0,11 Kg / Glass MEDIUM	Spika
		0,15 Kg / Glass LARGE	Spika
Standard restaurant	 	0,15 Kg / Customer	Alfa / Gala / Delta Max / Pulsar / Quasar
Restaurant	 	0,3 Kg / Customer	Alfa / Gala / Delta Max / Pulsar / Quasar
Seafood establishment	 	0,5 Kg / Customer	Alfa / Gala / Delta Max / Pulsar / Quasar
		1,25 Kg / Customer	IQ
Hotel		0,3 Kg / Room	Alfa / Gala / Delta Max / Pulsar
Camping		0,3 Kg / Plot	Alfa / Gala / Quasar
		0,8 Kg / Plot	IQ
Residence		0,2 Kg / Room	Alfa / Gala / Quasar

	SOLID ICE CUBE
	FULL/HALF DICE
	HOLLOW CUBE
	NUGGET ICE
	GRANULAR ICE
	FLAKE ICE

	TYPE OF ICE	QUANTITY	RANGE
Food/Drink exposition		1 Kg / Simple ice bucket	IQ / Quasar / Nugget
		6 Kg / Ice bucket	IQ / Quasar / Nugget
Seafood tray		1,3 Kg / SMALL tray	IQ / Scala
		3 Kg / MEDIUM tray	IQ / Scala
		6 Kg / LARGE tray	IQ / Scala
Buffet on ice 10cm.		70 Kg / m ²	IQ
		12 Kg / gastronorm tray 1/1	IQ
Fish market exposition		1m ² 10 cm 100 Kg	IQ
		1m ² 10 cm 85 Kg	Scala
Fish market storage		0,30 Kg / 1 Kg fish	IQ
Hospital		0,30 Kg / Patient	Alfa / Gala
Laboratory		1 Kg / Bucket	IQ
		5 Kg / Fridge	IQ
Phisiotherapy		0,80 Kg / Patient	IQ
Rice-recuperation		0,5 Kg / Application	IQ
Spa's-Ice shower		150 Kg / Shower	IQ
Laser therapy		0,30 Kg / Patient	IQ
Fish industry		Storage 0,30 Kg / 1 Kg fish	IQ / Scala
		Cool embarked 1 Kg / 1 Kg pescado	IQ / Scala
		Tropical embarked 1 Kg / 1 Kg fish	IQ / Scala
Meat industry		0,25 Kg / 1 Kg	IQ / Scala
Bakery industry		0,20 Kg / 1 Kg	IQ / Scala
Dyes		0,50 Kg / 1 m ²	IQ / Scala
Cement		50 Kg / 1 m ³	Scala

	SOLID ICE CUBE
	FULL/HALF DICE
	HOLLOW CUBE
	NUGGET ICE
	GRANULAR ICE
	FLAKE ICE

APPLICATIONS

HOSTELERÍA & QSR



APPLICATIONS

INDUSTRY



APPLICATIONS

RETAIL



HEALTHY





C/31270_04/JJ/23

ITV ICE MAKERS, S.L.
POL. IND. SECTOR 13, AVDA. DELS HOSTALERS, 2 46394
RIBARROJA DE TURIA, VALENCIA, SPAIN
PHONE: +34 96 166 75 75 | FAX: +34 96 166 81 00
comercial@itv.es | www.itv.es