







SS1242 380 V/50Hz

ORBITAL SILO FOR SCALE ICE

FEATURES CARACTERÍSTICAS

- ▶ **DESIGNED TO STORE SCALE ICE UP TO 48 HOURS**
DISEÑADOS PARA ALMACENAR HIELO EN ESCAMA PLANA HASTA 48 HORAS
- ▶ **THE ORBITAL SILOS MUST BE INSTALLED IN COLD ROOMS TO OPERATE IN A TEMPERATURES RANGE FROM -4°C TO -10°C WITH STABLE RELATIVE HUMIDITY**
LOS SILOS ORBITALES SE DEBEN INSTALAR EN CÁMARAS PARA OPERAR EN UN RANGO DE TEMPERATURAS DE -4°C A -10°C CON HUMEDAD RELATIVA ESTABLE
- ▶ **LATERAL EXTRACTION SYSTEM THROUGH A SCREW CONVEYOR**
SISTEMA DE DESCARGA LATERAL DE HIELO MEDIANTE UN SINFIN
- ▶ **THE "TRASRO® SYSTEM" FACILITATES THE ICE EXTRACTION AND AVOIDS ICE BLOCK FORMATION**
EL "SISTEMA TRASRO®" FACILITA LA EXTRACCIÓN DEL HIELO EVITANDO LA FORMACIÓN DE BLOQUES
- ▶ **FIRST IN-FIRST OUT (FI-FO) ICE MANAGEMENT TO PREVENT FROM STORING "OLD" ICE**
GESTIÓN DEL HIELO FIRST IN-FIRST OUT (FI-FO) PARA EVITAR ALMACENAR HIELO "VIEJO"
- ▶ **ALL PARTS IN CONTACT WITH ICE ARE MADE OF STAINLESS STEEL**
TODOS LAS PIEZAS EN CONTACTO CON EL HIELO ESTÁN HECHAS DE ACERO INOXIDABLE
- ▶ **MODULAR CONSTRUCTION FULLY REMOVABLE AND TRANSFERABLE TO OTHER PLACEMENT**
CONSTRUCCIÓN MODULAR. TOTALMENTE DESMONTABLE Y TRASLADABLE A OTRO EMPLAZAMIENTO
- ▶ **ALL ITS MODULAR ELEMENTS CAN PASS THROUGH A 1.80 X 0.80 M DOOR, EASY ASSEMBLY IN EXISTING COLD ROOMS**
TODOS SUS ELEMENTOS MODULARES PUEDEN PASAR POR UNA PUERTA DE 1,80 X 0,80 M, FÁCIL MONTAJE EN CÁMARAS YA EXISTENTES
- ▶ **SAFETY DEVICE WITH ALARM INSTALLED IN THE BIN ACCESS DOOR TO PREVENT FROM ACCIDENTS**
DISPOSITIVO DE SEGURIDAD CON ALARMA INSTALADO EN LA PUERTA DE ACCESO AL SILO PARA EVITAR ACCIDENTES
- ▶ **THE ICE LEVEL CAN BE CONTROLLED THROUGH THE WINDOW IN THE BODY OF THE BIN**
LA ALTURA DEL HIELO PUEDE SER CONTROLADA A TRAVÉS DE LA VENTANA EN EL CUERPO DEL SILO
- ▶ **ELECTRICAL BOX IP55 (INGRESS PROTECTION AGAINST WATER SPRAY AND DUST)**
CUADRO ELÉCTRICO IP55 (PROTECCIÓN FRENTE A LAS SALPICADURAS DE AGUA Y EL POLVO)



	 (Tn)	 (m ²)	 (Kg/h)	 (mm)	 (External diameter)	
SS 1242	12	25	9.000	*Height 3.100	4.080	FLAKE ICE -7°C ICE TEMPERATURE 2% RELATIVE HUMIDITY

*Total height with base + 855mm with geared motor
*Altura total con base + 855mm con motor reductor

ACCESSORIES ACCESORIOS

INCLUDED



LEVELING LEGS
PATAS DE NIVELACIÓN



MICRO SECURITY DOOR
MICRO PUERTA DE SEGURIDAD



METHACRYLATE WINDOW
VENTANA DE METACRILATO

NOT INCLUDED (OPTIONAL)



ICE MECHANICAL STOP LEVEL
NIVEL DE PARO MECÁNICO HIELO

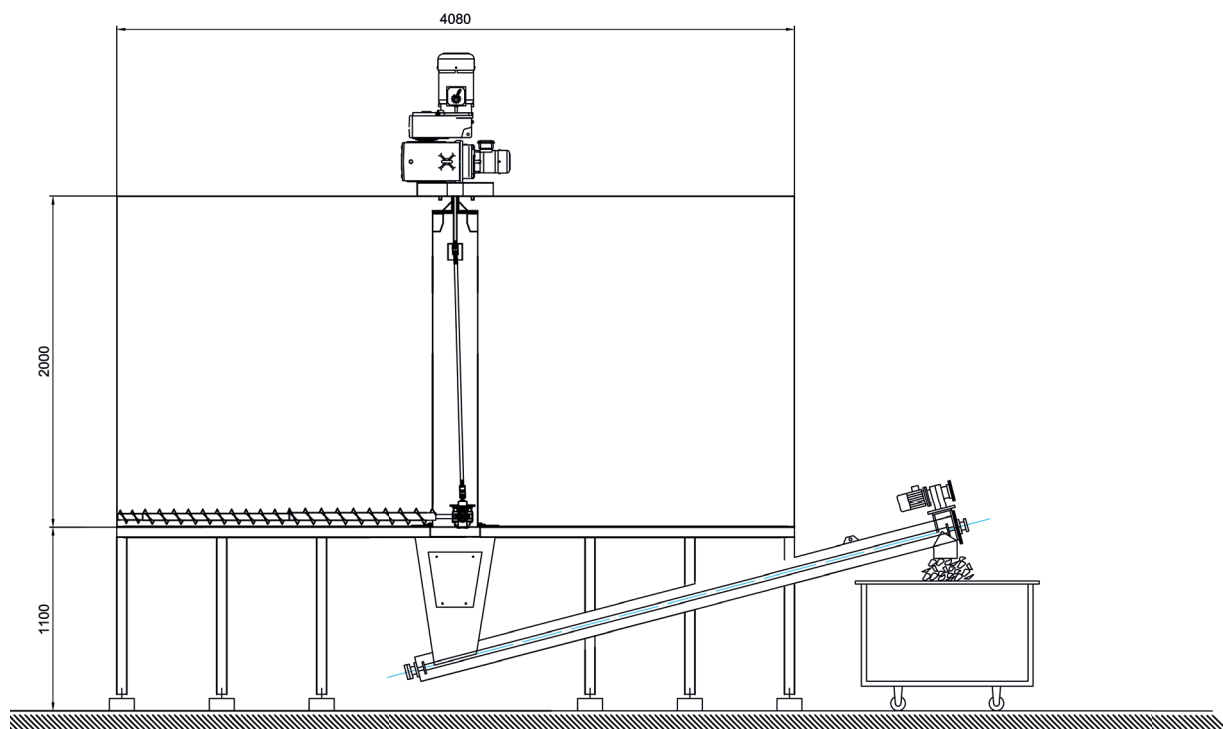

* All measurements in mm.
* Todas las cotas en mm.

OPERATING CONDITIONS CONDICIONES DE OPERACIÓN

⚡ 380 ±10% V

🏠 -4 / -10 °C

MODELS MODELOS	⚡ (W) 43°C	🌱 (n.) (mm ²)	🔌 FUZE (Amp)	📦 (Kg)	📏 WxDxH (mm)	📏 (m ²)	
SS 1242	5.750	5 2.5 / 1.5	1,2 / 2,7 / 7	1.700	4.000 x 1.000 x 800	3,20	Screw conveyor Transportador helicoidal
					1.700 x 1.400 x 1.200	2,58	Structure 1 Estructura 1
					1.000 x 1.000 x 1.300	1,30	Structure 2 Estructura 2
					4.100 x 200 x 2.150	1,76	Support ring Anillo de refuerzo
					1.500 x 1.100 x 1.200	1,98	x2 Panels x2 Paneles
					850 x 650 x 1.000	0,55	Motors Motores



ITV ICE MAKERS, S.L.
POL. IND. SECTOR 13, AVDA. DELS HOSTALERS, 2
46394 RIBARROJA DE TURIA, VALENCIA, SPAIN
PHONE: +34 96 166 75 75 | FAX: +34 96 166 81 00
info@itv.es | www.itv.es



SERVICE
SERVICIO ASISTENCIA TÉCNICA
service@itv.es
Skype: ITV.Service
+34 961 667 639
8:00AM | 7:00PM



Subject to certain limitations
and exclusions. **Only spare parts.**
Sujeto a limitaciones y exclusiones.
Solo piezas de repuesto.



9000
9001
14000

