

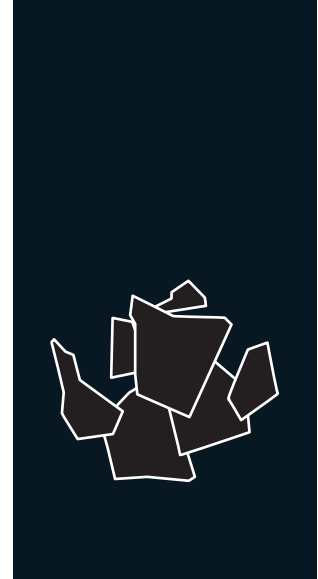









SCALA 3000 CO₂ SPLIT 230 V / 50 Hz

MODULAR FLAKE ICE MACHINE SPLIT

FEATURES CARACTERÍSTICAS

- ▶ **PRODUCES COLD AND DRY FLAT FLAKES. FLAKE THICKNESS MAY BE ADJUSTED BETWEEN 1.5 mm AND 3 mm**
PRODUCE ESCAMAS PLANAS MUY FRÍAS Y SECAS. EL ESPESOR PUEDE REGULARSE ENTRE 1.5 Y 3 mm
- ▶ **BASED ON A STATIC CYLINDER WHICH IS FREE FROM SWIVEL JOINTS (HELICAL REAMER) COUPLED WITH A MILLING TOOL THAT DETACHES THE ICE WITHOUT ANY STRAINED OR FORCED MOVEMENTS**
FUNCIONAMIENTO BASADO EN UN CILINDRO ESTÁTICO SIN JUNTAS GIRATORIAS (HELICAL REAMER) Y CON UNA FRESA QUE DESPEGA EL HIELO SIN TENSIONES NI ESFUERZOS
- ▶ **THE MOST EFFICIENT EVAPORATOR OF THE MARKET, LESS ENERGY CONSUMPTION AND HIGHER ICE PRODUCTION**
EL EVAPORADOR MAS EFICIENTE DEL MERCADO, MENOR GASTO ENERGÉTICO, MAYOR PRODUCCIÓN DE HIELO
- ▶ **ELECTRONIC EXPANSION VALVE / SUCTION REGULATING VALVE / STOP WHEN FULL BIN STOP WITH PHOTOELECTRICAL SENSOR / FOR CONNECTING TO CO2 COOLING UNIT ALWAYS IN SUBCRITICAL STATE**
VÁLVULA DE EXPANSIÓN ELECTRÓNICA / VÁLVULA REGULADORA DE ASPIRACIÓN/ PARO POR LLENADO DE CUBA CON CÉLULA FOTOELÉCTRICA / PARA CONECTAR A CENTRAL DE CO2 EN ESTADO SUBCRÍTICO
- ▶ **ELECTRONIC STOP SYSTEM / ELECTRICAL CONTROL PANEL / DRIVE DIRECT GEAR MOTOR / MAGNETIC DRIVE PUMP / LOW WATER SAFETY DEVICE**
SISTEMA DE PARO ELECTRÓNICO / CUADRO ELÉCTRICO DE REGULACIÓN / MOTORREDUCTOR DE ATAQUE DIRECTO / BOMBA DE ARRASTRE MAGNÉTICO / SEGURIDAD ANTE FALTA DE AGUA
- ▶ **STAINLESS STEEL SOLEPLATE**
BANCADA DE ACERO INOXIDABLE
- ▶ **CONTROLLERS TO DETECT: LOW WATER LEVEL, TEMPERATURE RISE DUE TO MOTOR OVERLOAD OR FULL VAT**
CONTROLES PARA DETECTAR: FALTA DE NIVEL DE AGUA, AUMENTO DE TEMPERATURA POR SOBRESFUERZO EN EL MOTORREDUCTOR O POR LLENADO DE ALMACÉN



	 24 H	 10°C (Kg)	 10°C (Kg)	 21°C (Kg)	 15°C (Kg)	 (mm)	 (mm)	
SCALA 3000 CO ₂ SPLIT 		3.300	3.000	Width 1.050 Depth 750 Height 1.300	Width 1.200 Depth 975 Height 1.330			FLAKE ICE -7°C Ice Temperature

ACCESSORIES ACCESORIOS

INCLUDED



WATER INLET FILTER GASKET
JUNTA DE FILTRO DE ENTRADA DE AGUA

WATER INLET HOSE
MANGUERA DE ENTRADA DE AGUA

WATER OUTLET HOSE
MANGUERA DE DESAGÜE

OPTIONAL (NOT INCLUDED)



ICE DROP CHUTE
TUBO DE CAÍDA DE HIELO

SALT DOSING PUMP WITH TANK
BOMBA DOSIFICADORA DE SAL CON DEPÓSITO

REMOTE SWITCH
INTERRUPTOR REMOTO

REMOTE SWITCH & WEEKLY PROGRAMMER
INTERRUPTOR REMOTO CON PROGRAMADOR SEMANAL

EXTERNAL STOP FULL BIN PHOTO CELL
SENSOR DE PARO EXTERNO POR LLENADO

Y EXTENSION INOX
EXTENSIÓN Y INOX

RECOMMENDED BINS DEPÓSITOS RECOMENDADOS



S500 + SCALA 3000 CO2 SPLIT

SCD400 + SCALA 3000 CO2 SPLIT

SCD600 + SCALA 3000 CO2 SPLIT

SCD800 + SCALA 3000 CO2 SPLIT

SS221 + SCALA 3000 CO2 SPLIT

SS422 + SCALA 3000 CO2 SPLIT

SCALA 3000 CO₂ SPLIT

RIGHT SIDE VIEW
VISTA LATERAL DERECHA

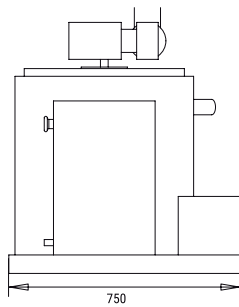

FRONTAL VIEW
VISTA FRONTAL

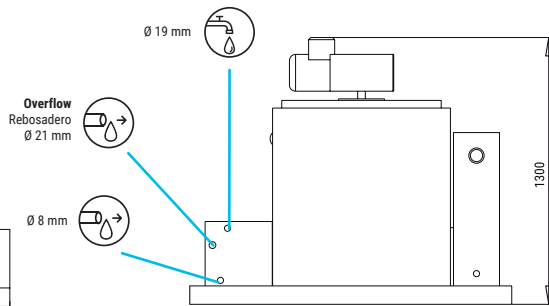

LEFT SIDE VIEW
VISTA LATERAL IZQUIERDA

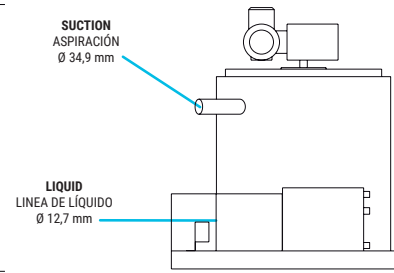

CENTRAL CROSS SECTION VIEW OF THE BASE
VISTA DE LA BASE DESDE SECCIÓN CENTRAL

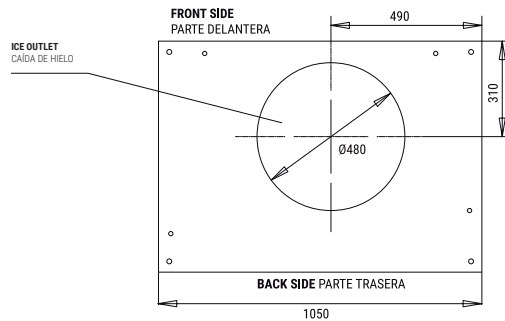

* All measurements in mm.
* Todas las cotas en mm.

OPERATING CONDITIONS CONDICIONES DE TRABAJO

PRODUCTION 50Hz PRODUCCIÓN 50 Hz

±10% V

10°C/43°C

5°C/38°C

1 bar/6 bar

V	Hz	ph
230	50	1N

SCALA 3000 CO₂ SPLIT

°C °F	10° 50°	15° 60°	21° 70°	30° 86°
	10° 50°	3300	3100	2700
21° 68°	3270	3000	2600	2370
32° 90°	3100	2800	2400	2150
43° 109°	2550	2370	1950	1800

SCALA 3000 CO₂ SPLIT

°C °F	10° 50°	15° 60°	21° 70°	30° 86°
	10° 50°	3069	2883	2511
21° 68°	3041	2790	2418	2204
32° 90°	2883	2604	2232	2000
43° 109°	2372	2204	1814	1674

MODELS MODELOS

Temp.EV. (°C)	ASHRAE CONDITIONS CONDICIONES ASHRAE (W) (BTU/h)	(W) 43°C	(n.) (mm ²)	FUSE	100 Kg (Kw/h)	(l/h)	HEAT REJECTED (W) (BTU/h)	(Kg)	(Kg)	(m ³)			
SCALA 3000 CO ₂ S	-22	16.500 56.300	200	3	1,5	16	7,8*	125	-	-	280	330	1,49

* WHEN INDICATED COOL REQUIREMENT IS SUPPLIED / CUANDO SE SUMINISTRA LA POTENCIA FRIGORÍFICA REQUERIDA



ITV ICE MAKERS, S.L.
POL. IND. SECTOR 13, AVDA. DELS HOSTALERS, 2
46394 RIBARROJA DE TURIA, VALENCIA, SPAIN
PHONE: +34 96 166 75 75 | FAX: +34 96 166 81 00
info@itv.es | www.itv.es



SERVICE
SERVICIO ASISTENCIA TÉCNICA
service@itv.es
Skype: ITV.Service
+34 961 667 639
8:00AM | 7:00PM



Subject to certain limitations
and exclusions. **Only spare parts.**
Sujeto a limitaciones y exclusiones.
Solo piezas de repuesto.

