

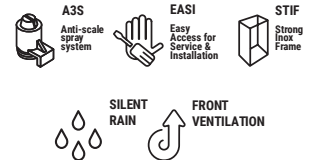

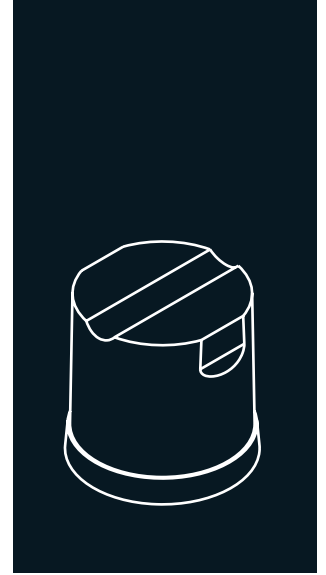









DELTA NG80 230 V / 50 Hz

GOURMET EISKEGELBEREITER MIT BEHÄLTER

EIGENSCHAFTEN

- ▶ PRODUZIERT FESTE, KRISTALLKLARE GOURMETEISKEGEL
- ▶ A3S: ANTI-KALK SPRAY-SYSTEM. DAS ITV-PATENTIERTE SPRÜHSYSTEM MIT FLEXIBLEN DÜSEN VERMEIDET KALKANSAMMLUNGEN MIT KLEINE VIBRATIONEN
- ▶ SMART FRONT VENTILATION SYSTEM (SFVS). FRONTALE VENTILATION ERMÖGLICHT EINE UNTERBAU-INSTALLATION DES GERÄTS. VÖLLIG EINBAUFÄHIG
- ▶ REINIGUNGSSCHALTER: SCHALTET DAS KÜHLSYSTEM WÄHREND DES ENTKALKUNGSVORGANGES AUS (CALCLIN ODER ÄHNLICH)
- ▶ NEVER STOP MOTOR PUMP VON ITV ENTWICKELTE MOTORPUMPE. SEIN DESIGN OHNE ABDICHTUNGEN VERHINDERT DIE VERFÄLLUNG IM HARTWASSER
- ▶ EASI: EINFACHER ZUGANG FÜR SERVICE & INSTALLATION. ALLE PLANELS KÖNNEN SEPARAT DEMONTIERT WERDEN
- ▶ HÖHENVERSTELLBARE FÜBE VON 105 MM BIS 155 MM
- ▶ STIF: STRONG INOX FABRICATION. STARKE INOX-HERSTELLUNG. FESTE STRUKTUR DURCH 4 INTERNE STAHLSÄULEN. KÖRPER AUS EDELSTAHL AISI 304
- ▶ STÄRKSTES BEHÄLTERTÜRÖFFNUNGSSYSTEM AUF DEM MARKT, ITV PATENTIERT. TÜR AUS EDELSTAHL AISI 304



	 24 H	 10°C (Kg)	 10°C (Kg)	 21°C (Kg)	 15°C (Kg)	 (Kg)	 (mm)	 (mm)	
DELTA NG80 L		87	80	35	Breite 715 Tiefe 595 Höhe 939*	Breite 780 Tiefe 680 Höhe 1.075	DELTA 36/40cc <small>38 (Ø) x 38 mm (H) DURCHSCHNITTSGRÖÙE</small>		
DELTA NG80 W		87	80						

* MIT FÜÙEN 1.044/1.199

ZUBEHÖR

EINBEGRIFFEN



EMPFOHLEN



TECHNISCHE DATEN

DELTA NG80

RECHTE SEITENANSICHT

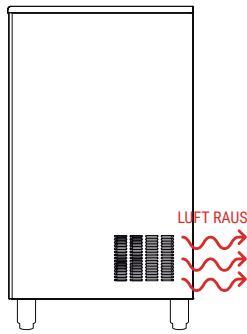

FRONTANSICHT

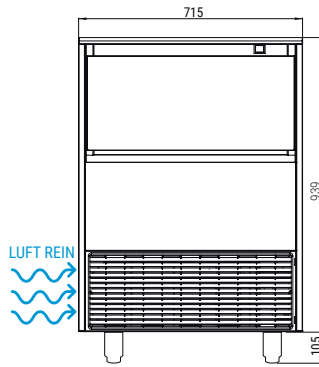

LINKE SEITENANSICHT

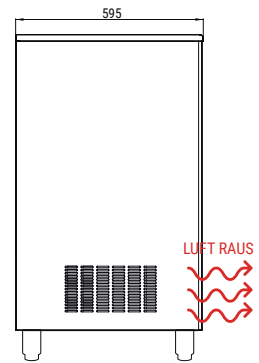

RÜCKANSICHT

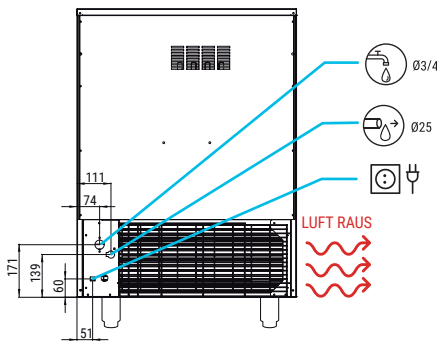

* Alle Größen in mm.

LEISTUNGEN

PRODUKTION 50Hz

±10% V

10°C/43°C

5°C/38°C

1 bar/6 bar

48 Eiskegel/Zyklus

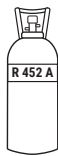

V	Hz	ph
230	50	1N

DELTA NG80 LUFTGEKÜHLT

°C / °F	10° / 50°	15° / 60°	21° / 70°	30° / 86°
10° / 50°	87	86	75	63
21° / 68°	81	80	69	56
32° / 90°	73	72	62	49
43° / 109°	55	54	44	31

DELTA NG80 WASSERGEKÜHLT

°C / °F	10° / 50°	15° / 60°	21° / 70°	30° / 86°
10° / 50°	87	86	75	63
21° / 68°	81	80	69	59
32° / 90°	73	72	65	54
43° / 109°	56	55	48	34

MODELLE

MODELLE	+c° / -c°	ASHRAE KONDITIONEN (W) (BTU/h)	(W) 43°C	(n.)	(mm ²)	SICHERUNG	100 Kg (Kwh)	(l/h)	(W) (BTU/h)	(Kg)	(Kg)	(m ³)
DELTA NG80 L		1.770 6.043	800	2	1,5	10	23,7	10,6	1.401 4.783	63	81	0,57
DELTA NG80 W		1.770 6.043	800	2	1,5	10	23,7	68,6	1.401 4.783	63	81	0,57



ITV ICE MAKERS, S.L.
POL. IND. SECTOR 13, AVDA. DELS HOSTALERS, 2
46394 RIBARROJA DE TURIA, VALENCIA, SPAIN
PHONE: +34 96 166 75 75 | FAX: +34 96 166 81 00
info@itv.es | www.itv.es



SERVICE
service@itv.es
Skype: ITV.Service
+34 961 667 639
8:00AM | 7:00PM



Auf Teile und Lohn.
Vorbehaltlich bestimmter
Einschränkungen und
Ausschlüsse.



SPRÜHSYSTEM
HORIZONTALER VERDAMPFER